



晶体管光耦
Photo Transistor

AT816X

Product Data Sheet

AOTE DCC
RELEASE

台湾奥特半导体科技有限公司

TAIWAN AOTE SEMICONDUCTOR TECHNOLOGY CO.,LTD

www.aotesemi.com

概述 Description

AT816X是一款由发光二极管和光电晶体管组成的光电耦合器。四引脚封装，三种形式（DIP、DIP-M、SMD）。

The AT816X is a photoelectric coupler composed of light-emitting diode and phototransistor. It is packaged in a 4-pin package of three forms such as DIP、DIP-M、SMD.

特性 Features

- 电流转换比(CTR)范围: CTR : 50% ($I_F = 5\text{mA}$, $V_{CE} = 5\text{V}$)
Current transfer ratio: CTR : 50% ($I_F = 5\text{mA}$, $V_{CE} = 5\text{V}$)
- 高输入-输出隔离电压 ($V_{ISO} = 5000 \text{Vrms}$)
High isolation voltage between input and output ($V_{ISO} = 5000 \text{Vrms}$)
- 工作温度: $-55^\circ\text{C} \sim 110^\circ\text{C}$
Operating Temperature: $-55^\circ\text{C} \sim 110^\circ\text{C}$
- 符合安规标准: UL 1577, VDE DIN EN60747-5-5 (VDE 0884-5), CQC11-471543-2022
Meet safety standard approval: UL 1577, VDE DIN EN60747-5-5 (VDE 0884-5), CQC11-471543-2022
- RoHs
- MLS1

应用 Applications

- 开关电源, 智能电表
Switching power supply, intelligent meter
- 可编程控制器
Programmable controllers
- 家用电器, 比如空调、风扇、热水器等
Household appliances: such as air conditioners, fans, water heaters, etc.

封装和原理图 Package and Schematic Diagram

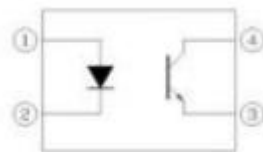

Pin Configuration

1. Anode
2. Cathode
3. Emitter
4. Collector



产品型号命名规则 Order Code

AT 816 X- UN Y - W (V) (ZZ)

① ② ③ ④ ⑤ ⑥ ⑦ ⑧

- ① 公司代码 Company Code (AT: 奥特 AOTE)
- ② 产品系列 Product Series (816 : 816)
- ③ CTR档位 Classification (代码 Code: C or D)
- ④ 框架类型 Lead Frame (Cu: 铜框架 Copper , Fe : 铁框架 Ferrum)
- ⑤ 树脂类型 Epoxy Type (H: 无卤 Halogen-free)
- ⑥ 封装形式 Package (D:DIP,S:SMD,M:DIP-M)
- ⑦ 细分档位 Subdivion Code (T : D1 , Y : D2)
- ⑧ 内部补充代码 Internal Supplementary Code (数字或者空白 Number or None)

印字信息 Marking Information

- 印字中 “” 为奥特品牌 LOGO
 “” denotes LOGO
- 印字中 “Y” 代表年份: A(2018), B(2019), C(2020).....
 “Y” denotes YEAR : A(2018), B(2019), C(2020).....
- 印字中 “WW” 代表周号
 “WW” denotes Week' s number
- 印字中 “N” 代表星期几
 “N” denotes the day of the week
- 印字中的 “H” 代表无卤
 “H” denotes Halogen-free



绝缘和安规信息 Insulation and Safety related specifications

项目 Item	符号 Symbol	数值 Value	单位 Unit	备注 Remark
爬电距离 Creepage Distance	L	>7.0	mm	从输入端到输出端，沿本体最短距离路径 Measured from input terminals to output terminals, shortest distance path along body
电气间隙 Clearance Distance	L	>7.0	mm	从输入端到输出端，通过空气的最短距离 Measured from input terminals to output terminals, shortest distance through air
绝缘距离 Insulation Thickness	DTI	>0.4	mm	发射器和探测器之间的绝缘厚度 Insulation thickness between emitter and detector
峰值隔离电压 Peak Isolation Voltage	V_{IORM}	1500	V_{peak}	DIN/EN/IEC EN60747-5-5
瞬态隔离电压 Transient isolation voltage	V_{IOTM}	7000	V_{peak}	DIN/EN/IEC EN60747-5-5
隔离电压 Isolation Voltage	V_{ISO}	>5000	V_{rms}	For 1 min, RH < 60%

极限参数 Absolute Maximum Ratings (TA = 25°C)

参数 Parameter		符号 Symbol	额定值 Rating	单位 Unit
发射端 Input	正向电流 Forward Current	I_F	50	mA
	反向电压 Reverse Voltage	V_R	6	V
	峰值正向电流(1us, 脉冲) Peak forward current (1us, pulse)	I_{FP}	1000	mA
	功耗 Power Dissipation	P_D	70	mW
接收端 output	集电极功耗 Collector Power Dissipation	P_C	50	mW
	集电极电流 Collector Current	I_C	150	mA
	集电极-发射极电压 Collector-Emitter Voltage	V_{CEO}	80	V
	发射极-集电极电压 Emitter-Collector Voltage	V_{ECO}	7	V
总功耗 Total Power Dissipation		P_{tot}	200	mW
隔离电压 Isolation Voltage		V_{ISO}	5000	V_{rms}
工作温度 Operating Temperature		T_{opr}	-55~+110	°C
存储温度 Storage Temperature		T_{stg}	-55~+125	°C
焊接温度 Soldering Temperature		T_{sol}	260	°C

产品特性参数 Electro-optical Characteristics (T_A = 25°C)

	参数 Parameter	符号 Symbol	条件 Condition	最小 Min.	典型 Typ.	最大 Max.	单位 Unit
发射端 Input	正向电压 Forward Voltage	V _F	I _F = 20mA	1.2	-	1.4	V
	反向电流 Reverse Current	I _R	V _R = 4V	-	-	10	μA
	终端电容 Terminal Capacitance	C _t	V = 0, F = 1kHz	-	30	250	pF
接收端 Output	集电极暗电流 Collector Dark Current	I _{CEO}	V _{CE} = 20V	-	-	100	nA
	集电极-发射极击穿电压 Collector-Emitter Breakdown Voltage	BV _{CEO}	I _C = 0.1mA, I _F = 0	80	-	-	V
	发射极-集电极击穿电压 Emitter-Collector Breakdown Voltage	BV _{ECO}	I _E = 10μA, I _F = 0	7	-	-	V
传输特性 Transfer Characteristics	电流传输比 Current Transfer Ratio	CTR*	I _F = 5mA, V _{CE} = 5V	200	-	600	%
	集电极-发射极饱和压降 Collector-Emitter Saturation Voltage	V _{CE(sat)}	I _F = 1mA, I _C = 1mA	-	-	0.4	V
	隔离电阻 Isolation Resistance	R _{ISO}	DC500V, 40 ~ 60% R.H.	1x10 ¹²	-	-	Ω
	隔离电容 Isolation capacitance	C _{ISO}	V = 0, F = 1MHz	-	0.6	1.0	pF
	截至频率 Cut-off Frequency	F _C	V _{CE} = 5V, I _C = 2mA, R _L = 100Ω, -3dB	-	80	-	KHz
	上升时间 Rise Time	T _r	V _{CE} = 10V, I _C = 2mA, R _L = 100Ω	4	-	18	μs
	下降时间 Fall Time	T _f	V _{CE} = 10V, I _C = 2mA, R _L = 100Ω	3	-	18	μs
	导通时间 Turn on time	T _{on}	V _{CE} = 10V, I _C = 2mA, R _L = 100Ω	-	-	12	μs
关断时间 Turn off time	T _{off}	V _{CE} = 10V, I _C = 2mA, R _L = 100Ω	-	-	12	μs	

 注* : 电流传输比 = I_C/I_F × 100%.

 Note* : CTR = I_C/I_F × 100%.

电流传输比分档表 CTR classification Table (V_{CE} = 5V, T_a = 25°C)

代码 code	分档 classification	符号 Symbol	条件 condition	最小值 Min	最大值 Max
电流传输比 Current Transfer Ratio	无	CTR	I _F = 5mA, V _{CE} = 5V	50	600
	A			80	160
	B			130	260
	C			200	400
	D			300	600

典型光电特性曲线 Typical Electro-Optical Characteristics Curves

Fig.1 Relative Current Transfer Ratio vs. Forward Current

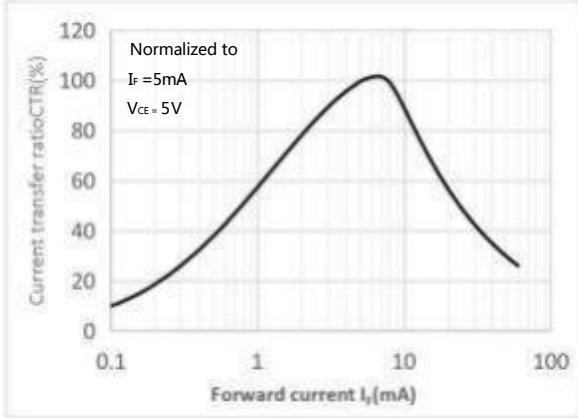

Fig.2 Forward Current vs. Forward Voltage

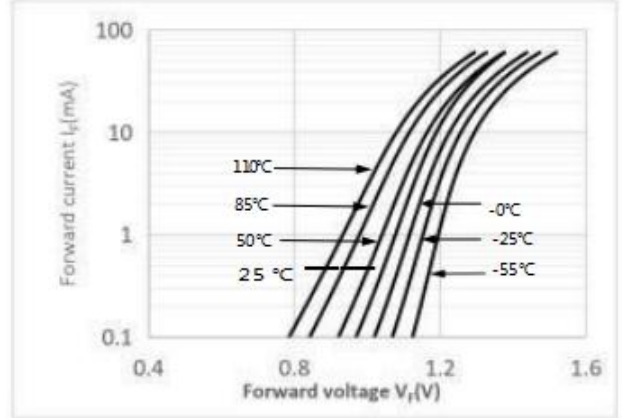

Fig.3 Collector Current vs. Collector-emitter Voltage

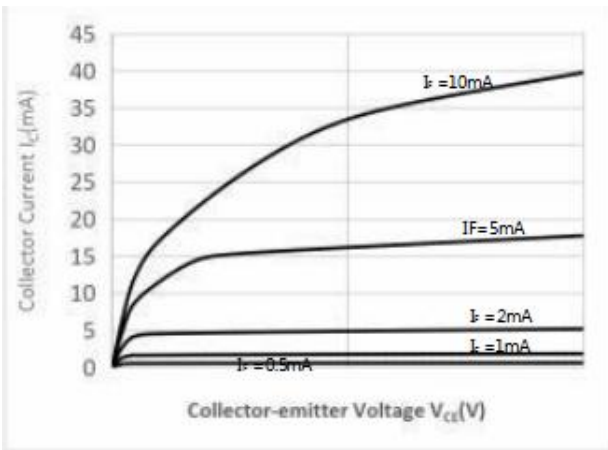

Fig.4 Relative Current Transfer Ratio vs. Ambient Temperature

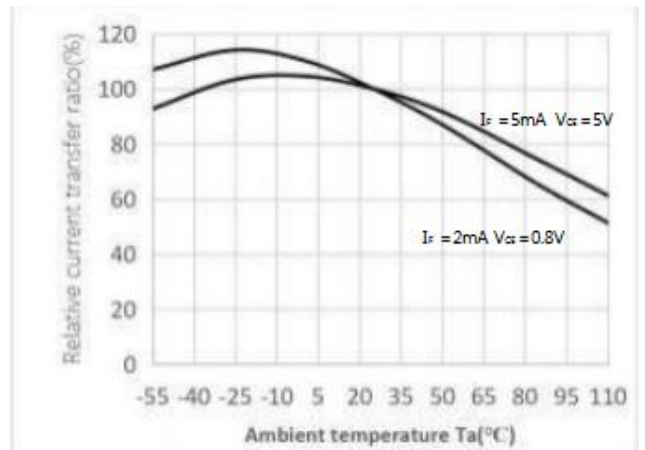

Fig.5 Collector-emitter Saturation Voltage vs. Ambient Temperature

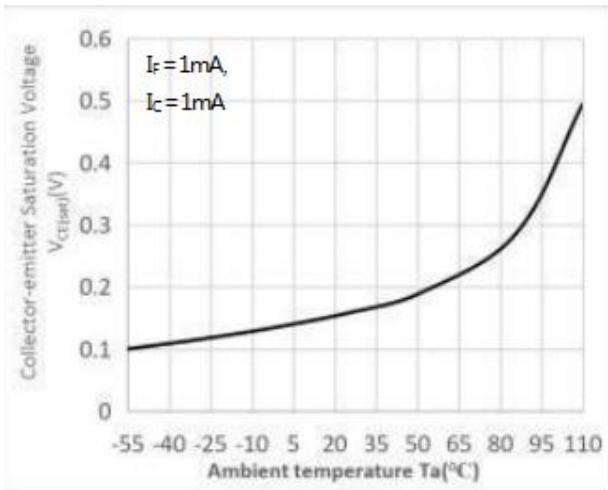

Fig.6 Collector Dark Current vs Ambient Temperature

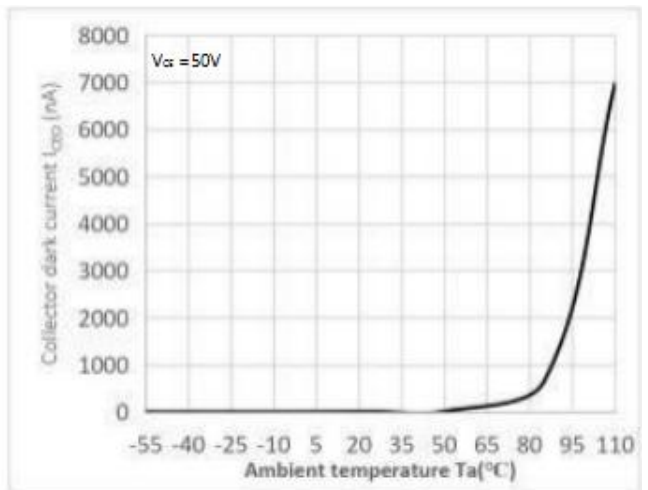

Fig.7 Response Time vs. Load Resistance

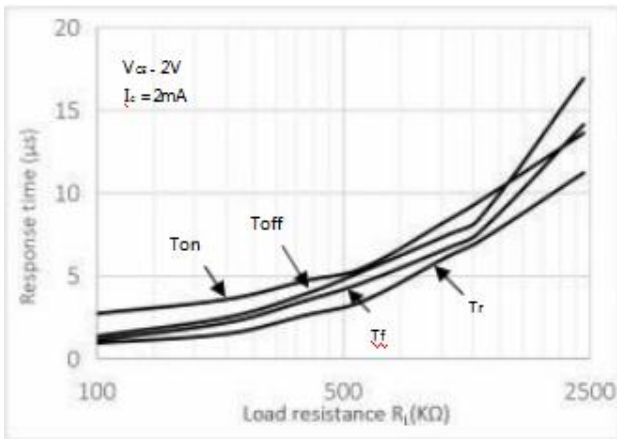

Fig.8 Frequency Response

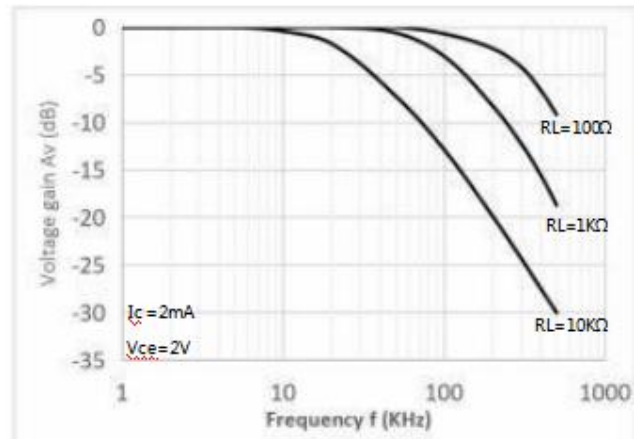

Fig.9 Collector-emitter Saturation Voltage vs Forward Current

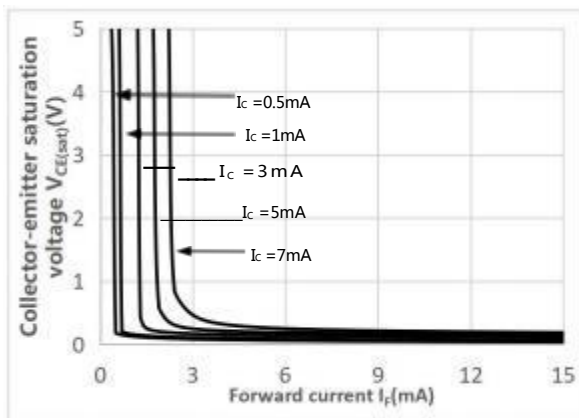
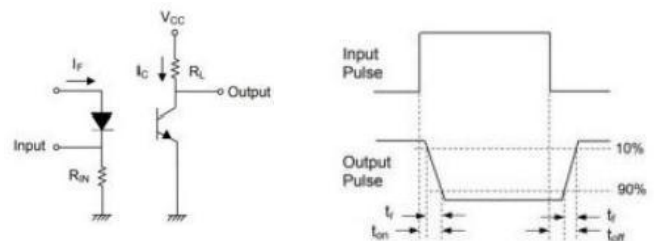
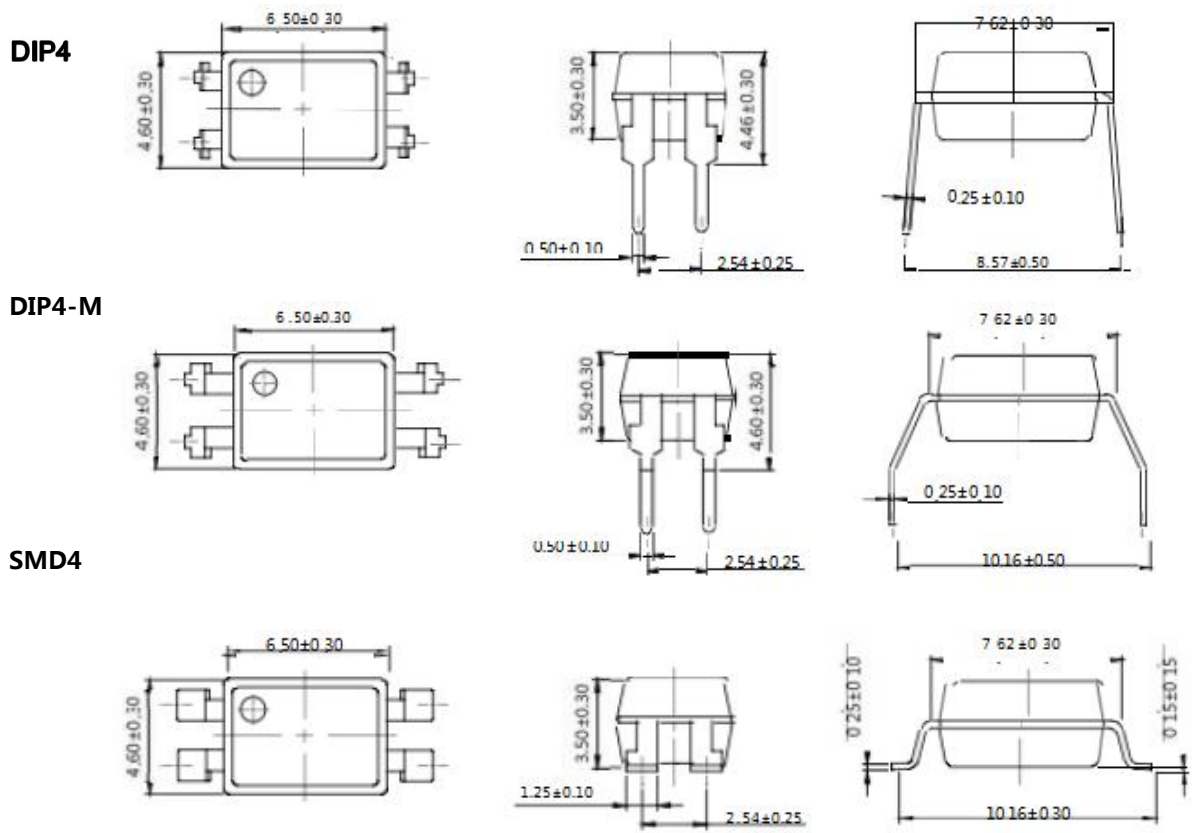

Fig.10 Switching Time Test Circuit & Waveforms



外形尺寸 Outline Dimensions



单位 Unit: mm

建议焊盘布局 Recommended Pad Layout

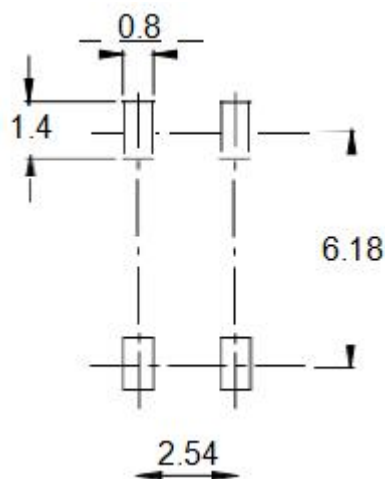

单位 Unit: mm

注：上图为产品正视图。

Note : The picture above is the front view of the product

回流焊温度曲线图 Solder Reflow Profile

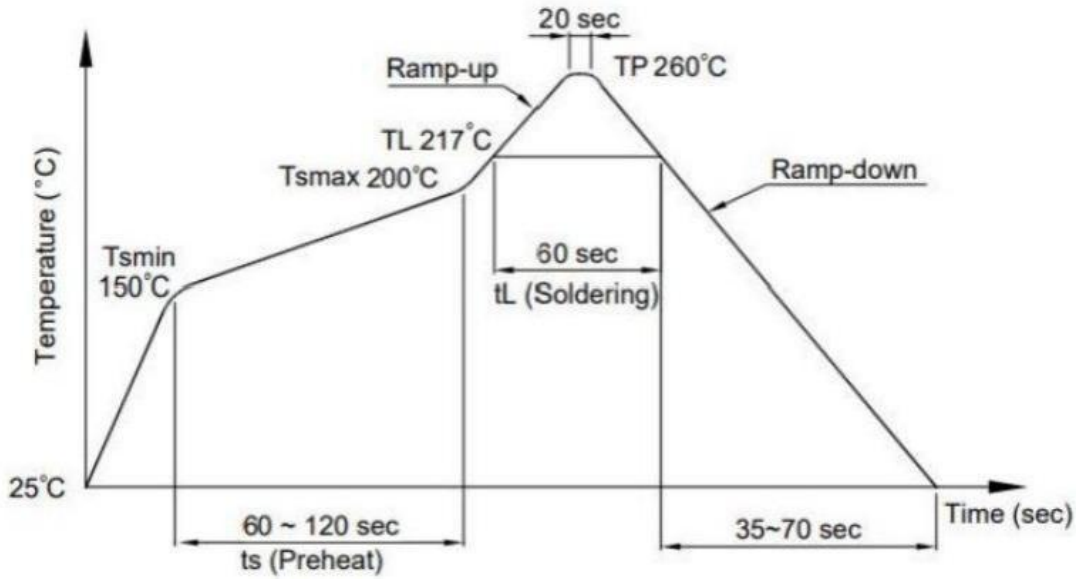

项目 Item	符号 Symbol	最小值 Min.	最大值 Max.	单位 Unit
预热温度 Preheat Temperature	T_s	150	200	°C
预热时间 Preheat Time	t_s	60	120	s
升温速率 Ramp-Up Rate (T_L to T_P)	-	-	3	°C/s
液相线温度 Liquidus Temperature	T_L	217		°C
时间高于 T_L Time Above T_L	t_L	60	150	s
峰值温度 Peak Temperature	T_P	-	260	°C
T_C 在 (T_P-5) 和 T_P 之间的时间 Time During Which T_C Is Between (T_P-5) and T_P	t_p	-	30	s
降温速率 Ramp-down Rate(T_P to T_L)	-	3	6	°C/s

注：建议在所示的温度和时间条件下进行回流焊，最多不能超过三次。

Note: Reflow soldering is recommended at the temperatures and times shown, no more than three times.

波峰焊温度曲线图 Wave Soldering Profile

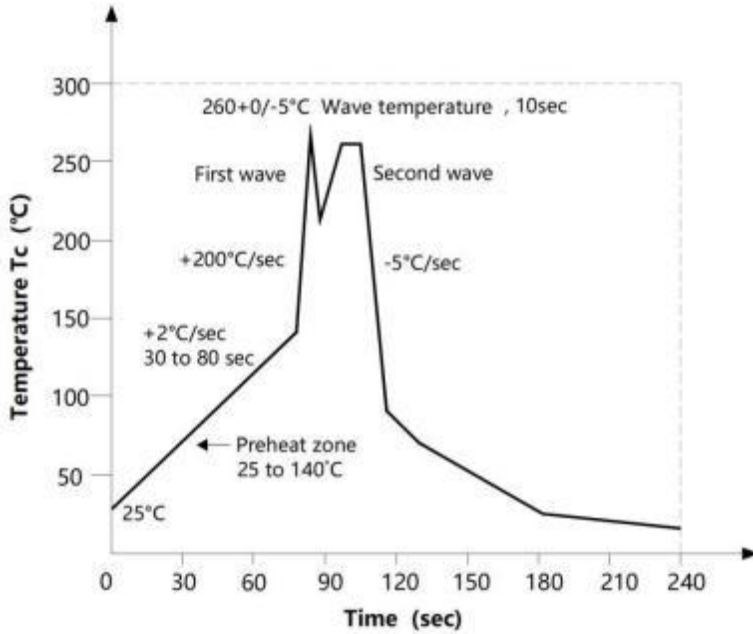

手工烙铁焊接 Soldering with hand soldering iron

- A. 手工烙铁焊仅用于产品返修或样品测试；
Hand soldering iron is only used for product rework or sample testing;
- B. 手工烙铁焊要求：温度 $360^{\circ}\text{C} \pm 5^{\circ}\text{C}$ ，时间 $\leq 3\text{s}$ 。
Manual soldering method Temperature: $360^{\circ}\text{C} \pm 5^{\circ}\text{C}$, within 3s.

包装 Packing

■ 汇总表 Summary table

封装形式	包装方式	盘数量	盒数量	箱数量	静电袋规格	盒规格	箱(双瓦楞)规格	备注
SMD4	卷盘 ($\phi 330\text{mm}$ 蓝盘)	1500只/盘	2盘/盒	10盒/箱	450*390*0.1mm	340*60*340mm	620*360*365mm	首尾端空至少200mm
DIP4	管装 (500*12*11mm)	100只/管	50管/盒	10盒/箱	不适用	525*128*56mm	535*275*300mm	每管使用蓝白胶塞，方向须一致
DIP4-M	管装 (500*13*11mm)	100只/管	50管/盒	10盒/箱	不适用	525*136*58mm	535*295*310mm	
Package Type	Packing Form	Quantity per Reel	Quantity per Box	Quantity per Carton	Antistatic Bag Specification	Box Specification	Carton Specification	NIote
SMD4	Reel ($\phi 330\text{mm}$ Blue)	1500 pcs/reel	2 reels/box	10 boxes/ctn	450*390*0.1mm	340*60*340mm	620*360*365mm	Leave at least 200mm of blank space at both ends
DIP4	Tube (500*12*11mm)	100 pcs/tube	50 tubes/box	10 boxes/ctn	NA	525*128*56mm	535*275*300mm	Use blue and white rubber plugs for each tube in the same direction
DIP4-M	Tube (500*13*11mm)	100 pcs/tube	50 tubes/box	10 boxes/ctn	NA	525*136*58mm	535*295*310mm	

■ 编带包装 Tape & Reel

- 1) 每卷数量：1500只。
Qty/reel：2000 pcs.
- 2) 每箱数量：30000只。
Qty/ctn：30000 pcs.
- 3) 内包装：每盒2盘。
Inner packing：2 reels/box.
- 4) 示意图 Schematic：

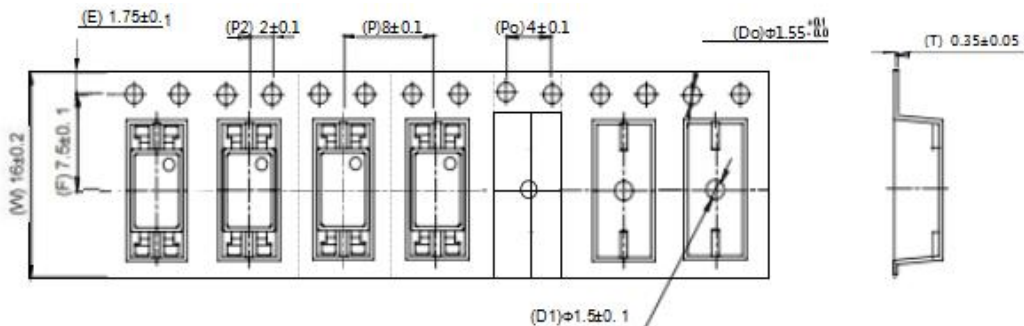

■ 管条包装 Tape & Tubel

- 1) 每管数量：100只。
Qty/Tube：100 pcs.
- 2) 每箱数量：50000只。
Qty/ctn：50000 pcs.
- 3) 内包装：每盒50管。
Inner packing：50Tube/box.
- 4) 示意图 Schematic：

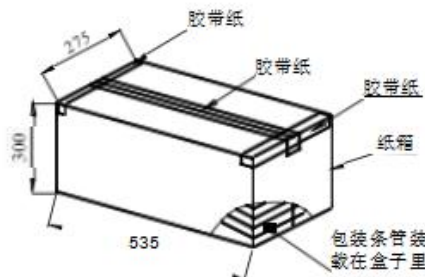

单位 Unit：mm

单位 Unit：mm

注意 Attention

- 奥特持续不断改进质量、可靠性、功能或设计，保留此文件更改的权利恕不另行通知。
AOTE continuously improve quality, reliability, function or design. We reserve the right to change this document without notice.
- 请遵守产品规格书使用，奥特不对使用时不符合产品规格书条件而导致的质量问题负责。
Please use in accordance with the product specification. AOTE is not responsible for the quality problems caused by non-compliance with the product specifications.
- 对于需要高可靠性或安全性的设备/装置需求，请联系我们的销售人员。
For equipment/devices where high reliability or safety is required, please contact our sales representatives.
- 当需要用于任何“特定”应用时，请咨询我们的销售人员。
When requiring a device for any “specific” application, please contact our sales in advice.
- 如对文件中表述的内容有疑问，欢迎联系我们。
If you have any questions about the contents of the document, please contact us.