

目录

Contents

1、特点 Features.....	1
2、应用 Applications.....	1
3、性能 Performance.....	2
4、产品代码 Product Order Code.....	3
5、光电特性图 The Photoelectric Characteristics Graph.....	4
6、产品及钢网尺寸 Product and PCB Pad Dimensions.....	6
7、回流焊特性 Reflow Soldering Characteristics.....	7
8、卷轴 Reel Dimensions.....	8
9、可靠性 Reliability	9
10、注意事项 Cautions.....	10
11、文件履历表 Document Resume	11

1、特点 Features

- ◆ 905nm Dtof 激光光源特性
Characteristics of 905nm Dtof laser projector
 - 波长@905nm
WaveLength@905nm
 - 典型光功率 4.8W (峰值功率@1.4A, 0.1%DC, DC=100ns)
Typical Optical Power 4.8W(Peak Power@1.4A, 0.1%DC, DC=100ns)
- ◆ 发光角度: 15~22°
Viewing Angle: 15~22°
- ◆ 尺寸: 3.20mm*3.0mm*0.6mm
Size: 3.20mm*3.0mm*0.6mm
- ◆ 适于 SMT 贴片
Compatible with SMT
- ◆ 包装: 最大 2000 颗/卷
Package : Max: 2000pcs /reel

德瑞光电

2、应用 Applications

用于户外辅助导航

Used for outdoor assisted navigation

AGV, 扫地机器人, 服务机器人

AGV, Sweeping robots, service robots

3、性能 Performance

a) 绝对最大额定值 Absolute Maximum Ratings

参数 Parameter	符号 Symbol	最大参数值 Maximum Rating	单位 Unit
峰值正向电流 Peak Forward Current	I_{op}	3.5	A
反向电压 Reverse voltage	V_r	50	V
工作温度 Operating Temperature	T_{opr}	-40~105	°C
工作湿度 Operating Humidity	H_{opr}	85	%
存储温度 Storage Temperature	T_s	-40~100	°C
存储湿度 Storage Humidity	H_s	85	%

b) 光电参数

Electro-Optical Characteristics ($T_A=25\text{ }^{\circ}\text{C}$, $I_F=1.4\text{A}$, 0.1%DC, DC=100ns)

项目 Item	符号 Symbol	最小值 Min.	典型值 Typ.	最大值 Max.	单位 Unit
中心波长 Wavelength	λ_{peak}	899	905	911	nm
输出光功率 Optical output power	P_{opt}	4.5	4.8	----	W
工作电压 Operating Voltage	V_{op}	16	18	22	V
阈值电流 Threshold current	I_{th}	----	0.02	----	A
发散角 Viewing Angle	Φ_{long}	15	18	22	°
温漂系数 Wavelength coefficient	$d\lambda/dT$	----	0.07	----	nm/°C

4、产品型号 Product Order Code

DRS905- 7000 - 10 -3030E

① ② ③ ④

- ① 峰值波长 Wavelength
- ② 输出光功率 Optical Power output
- ③ 芯片尺寸 Chip Size
- ④ 封装尺寸 Device Size (E=齐纳管)

出货标签(例) Shipping label (e.g.)

 			
品名:	半导体激光器件		
型号:			
批次号:	CP24010017		
制造日期:	2024/1/14	数量:	500PCS

5、光电特性图 The Photoelectric Characteristics Graph

投射器发射光谱 Projector emission spectrum

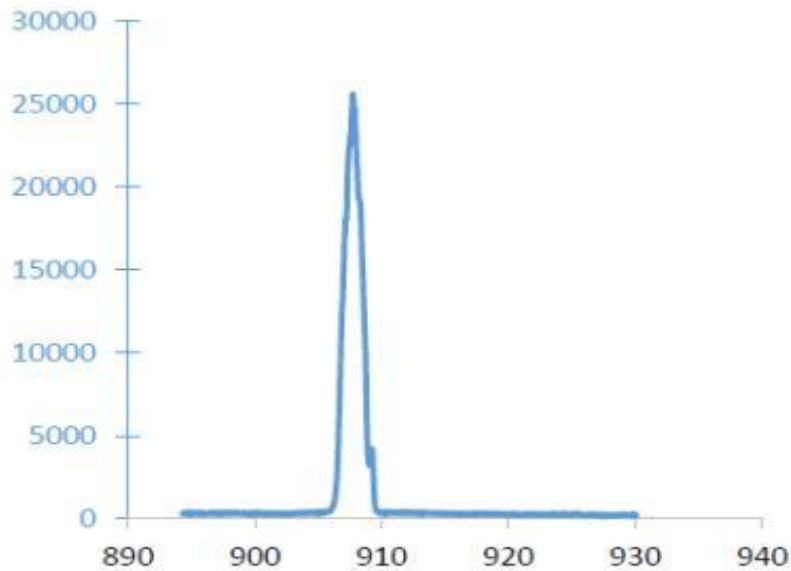

光- 电流- 电压曲线 LIV curve

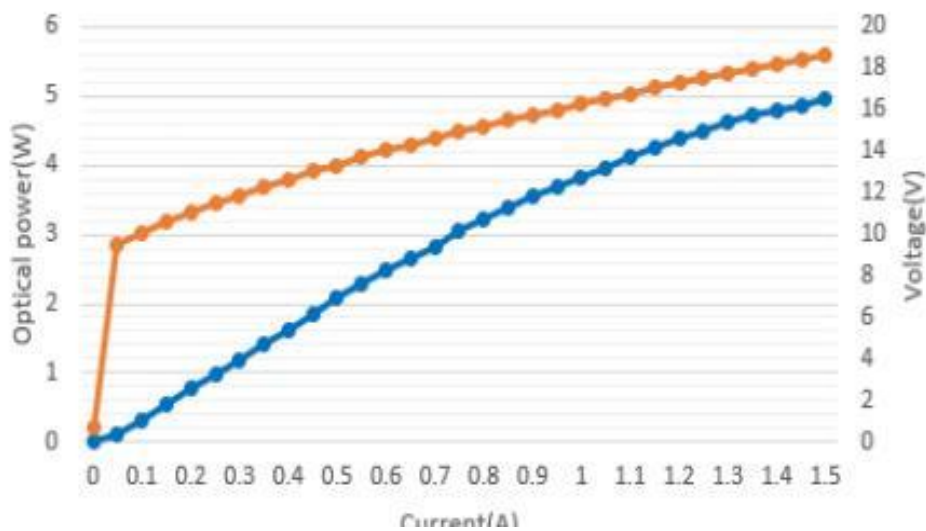

远场发射光斑 Far-Field Illumination Pattern

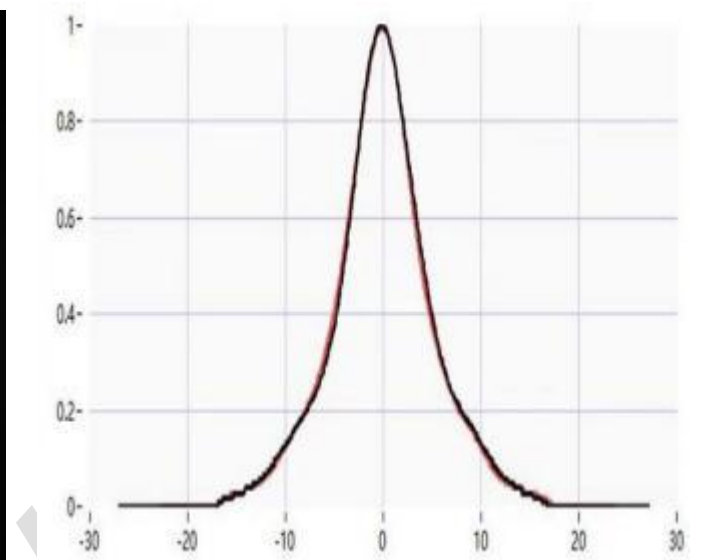
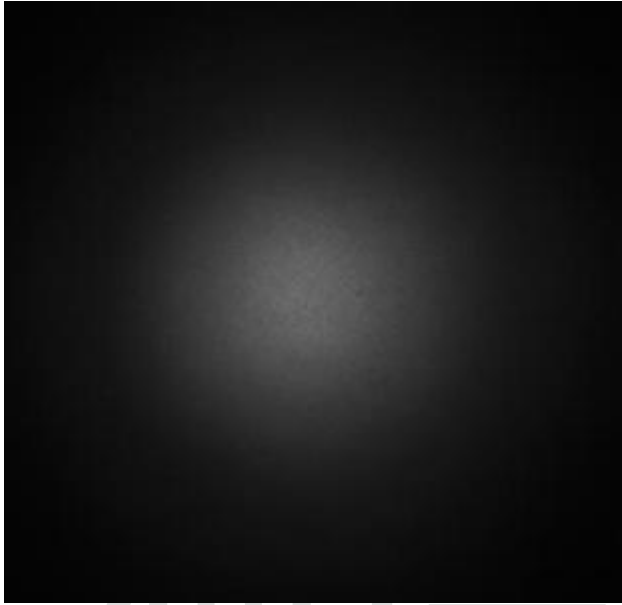

德瑞光电

6、产品及钢网尺寸 Product and PCB Pad Dimensions

Product Dimensions:

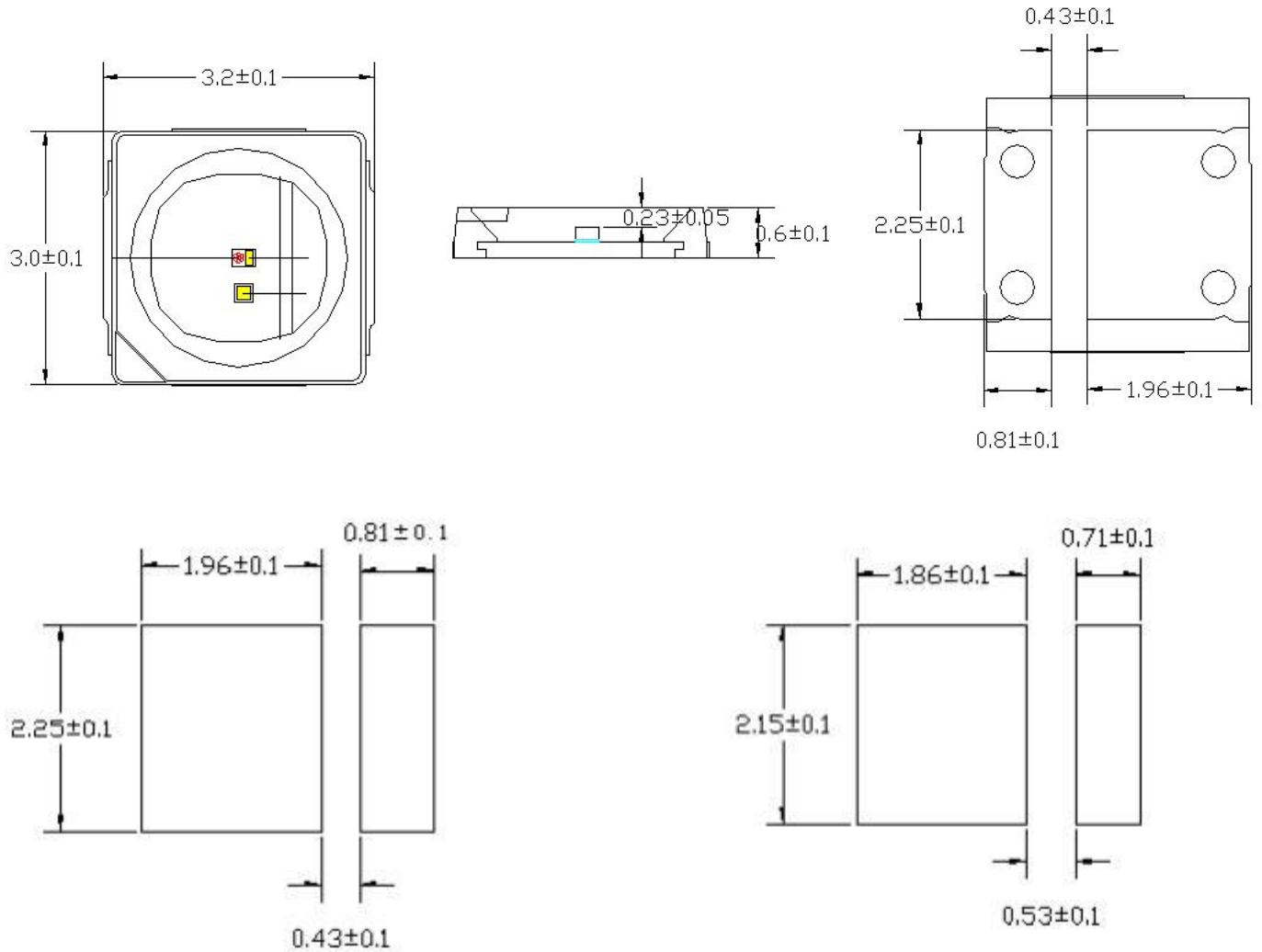

建议焊盘图

建议钢网图

备注 Notes:

- ❖ 所有尺寸均以 mm 为单位
All dimensions are in millimeters
- ❖ 尺寸未按照公差±0.1mm 标记的，按照图纸标记
Size is not marked in accordance with tolerance ±0.1mm and dimension tolerances in accordance with drawings

7、回流焊特性 Reflow Soldering Characteristics

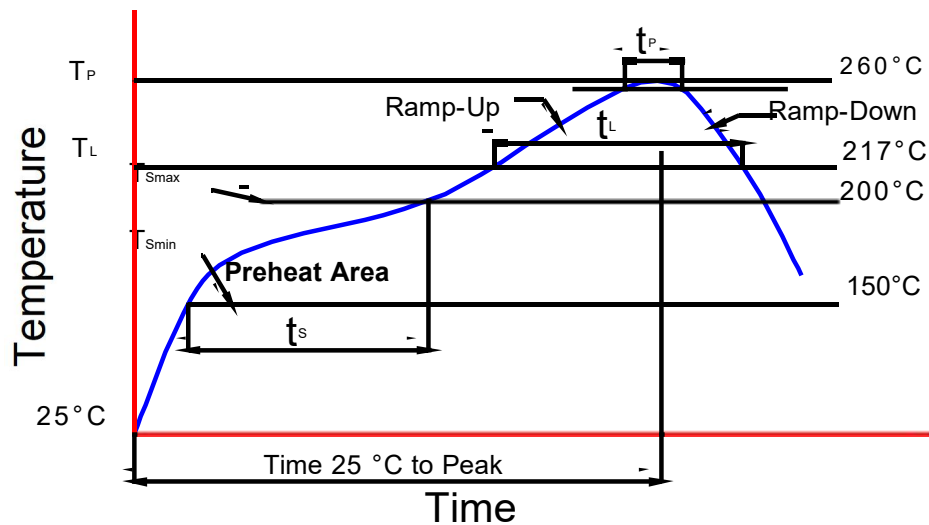

根据 EDEC-J-STD-020D 内容，参考以下内容。

Compatible with the JEDEC-J-STD-020D, using the parameters listed below.

特制参数 Profile Feature	无铅焊料 Lead-Free Solder
平均上升速率 (T _{Smax} 至 T _p) Average Ramp-Up Rate (T _{Smax} to T _p)	3 °C/sec max.
预热: 温度最小值 (T _{Smin}) Preheat: Temperature Min (T _{Smin})	150
预热: 最高温度 (T _{Smax}) Preheat: Temperature Max (T _{Smax})	200
预热: 时间 (t _{Smin} 到 t _{Smax}) Preheat: Time (t _{Smin} to t _{Smax})	60- 180 secs
回流温度 (T _L) Time Maintained Above: Temperature (T _L)	217°C
回流时间 (t _L) Time Maintained Above: Time (t _L)	60- 150 secs
峰值/分类温度 (T _p) Peak/Classification Temperature (T _p)	255 ± 5°C
实际峰值温度 (t _p) 在 5°C 以内的时间 Time Within 5°C of Actual Peak Temperature (t _p)	20~40 secs
降低速率 Ramp-Down Rate	5°C/sec max.

8、卷轴 Reel Dimensions

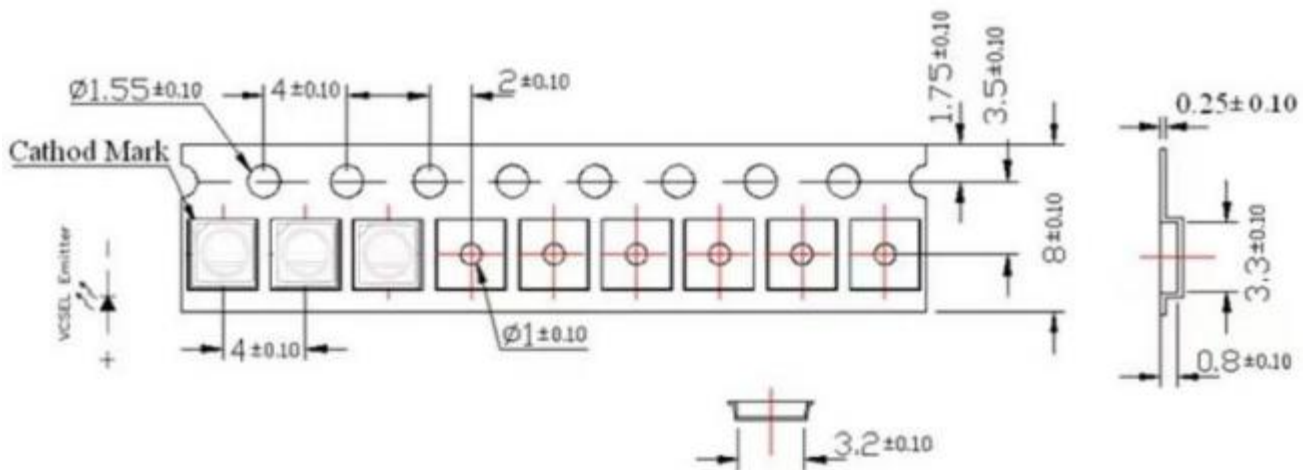
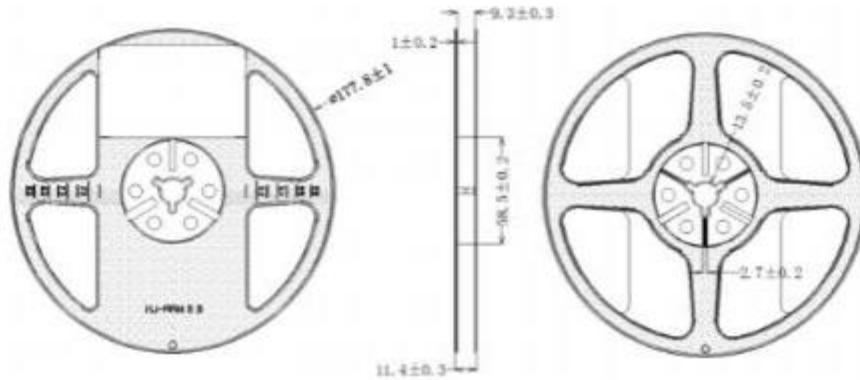
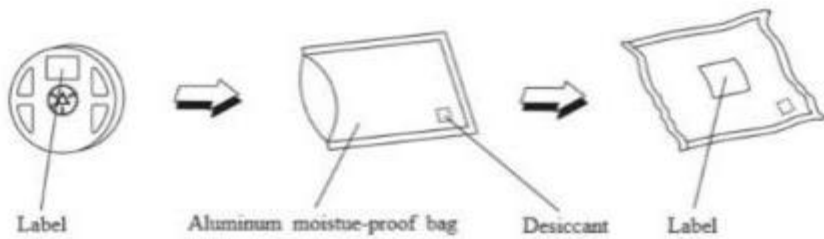

备注 Notes:

- ❖ 卷轴包装 2000pcs
Reel:2000pcs.
- ❖ 卷轴包装方法符合 IJSC0806 (连续胶带上的电子元件包装)
The tape packing method complies with IJSC0806(Packing of Electronic Components on Continuous Tapes).
- ❖ 当卷轴由于工作中断而重绕时, 载带上压力不应超过 10N, 否则投射器可能会粘在盖带上
When the tape is rewound due to work interruptions, no more than 10N should be applied to the embossed carrier tape.
The projectors may stick to the cover tape.

9、可靠性 Reliability

a) 测试和结果 Tests and Results

测试项目	测试条件	测试周期	失效数/测试数	失效标准
可焊性(回流焊)	$T_{sld}=255\pm 5^{\circ}\text{C}$, 5sec, Lead-free Solder (Sn-3.0Ag-0.5Cu)	3times	0/12	#2
冷热冲击	$-40^{\circ}\text{C} \sim 125^{\circ}\text{C}$, 1000 cycles	100cycles	0/12	#1
高温高湿存储	85°C , RH=85%	1000h	0/12	#1
低温存储	-40°C	1000h	0/12	#1

b) 失效判定 Failure Criteria

判定 Criteria #	项目 Items	条件 Conditions	失效判定 Failure Criteria
#1	外观	-	外观正常, 无胶裂
#2	回流焊	-	焊接面积 $<80\%$ 外观正常, 无胶裂

10、注意事项 Cautions

a) 存储 Storage

- 不要将芯片放在潮湿的地方，存放温度在 5°C~30°C之间，相对湿度在30%以下。
Do not place the chips in damp places, Storage temperature between 5 °C and 30 °C, Relative humidity under 30%.
- 开包后建议在 24 小时内过完回流焊，车间条件≤30°C/60%RH。
After opening the package, it is recommended to finish the reflow within 24 hours. The workshop conditions are ≤30°C/60%RH
- 如果受潮，需将贴片卷盘放入 60°C烤箱烘烤 24 小时；打开后，投射器可重新密封在原始真空袋中。
If it is wet, the patch reel should be baked in a 60 °C oven for 24 hours; after opening, the projector can be resealed in the original vacuum bag.
- 不要接触任何未知的液体，特别是丙酮。
Don't touch any unknown liquid, In particular, acetone.
- 防止静电死亡，手动操作需要戴橡胶手套并佩戴静电环。
Prevent electrostatic killed, Manual operation is required to wear rubber gloves and wear electrostatic ring.

b) 清洗 Cleaning

- 通常，投射器不建议对部件进行湿式清洁处理，因为封装不是密封的。
In general, Projector does not recommend a wet cleaning process for component as the package is not hermetically sealed.
- 由于采用开放式设计，所有类型的清洁液都可能渗透到封装中，导致投射器退化或完全失效。
Due to the open design, all kind of cleaning liquids can infiltrate the package and cause a degradation or a complete failure of the projector.

c) 操作注意 Handling Precautions

- 在处理过程中，还应注意确保组件顶面没有压力
During the handling, care should be taken as well to ensure no pressure on the top surface of component.
- 应避免使用所有类型的尖锐物体(例如镊子，指甲等)，以防止对硅树脂造成压力，因为这会导致部件损坏。
All types of sharp objects(e.g. forceps, fingernail, etc) should be avoided in order to prevent stress to the silicone, since this can lead to damage of the component.

11、文件履历表 Document Resume

序号	变更日期	变更人	版本	变更内容
1	2024.5.7	陈志彬	A00	新版发行

德瑞光电