



## TO-92 Plastic-Encapsulate Thyristors

### PCR406/PCR606 Silicon Controlled Rectifier

#### MAIN FEATURES

Symbol	Value	Unit
$I_{T(RMS)}$	0.6	A
$V_{DRM}$	PCR406	400
	PCR606	600
$T_j$	Junction Temperature	-40 ~ 125
$T_{stg}$	Storage Temperature	-40 ~ 150

#### TO-92

- 1.CATHODE
- 2.GATE
- 3.ANODE

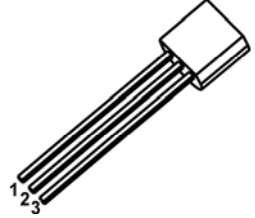

#### DESCRIPTION

Logic level sensitive gate triac intended to be interfaced directly to microcontrollers, logic integrated circuits and other low power gate trigger circuits.

#### FEATURES

- Blocking voltage to 400 V (PCR406)
- RMS on-state current to 0.6 A
- General purpose switching

#### APPLICATIONS

- General purpose switching
- Phase control applications
- Solid state relays

#### MARKING

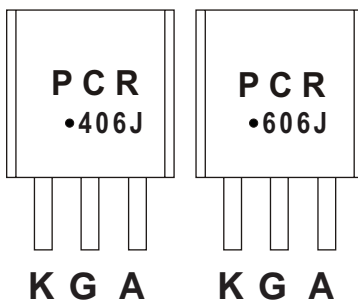

PCR406 PCR606=Device code

Solid dot=Green molding compound device, if none,the normal device

#### Equivalent Circuit

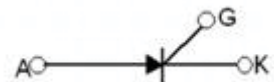

#### ORDERING INFORMATION

Part Number	Package	Packing Method	Pack Quantity
PCR406	TO-92	Bulk	1000pcs/Bag
PCR406-TA	TO-92	Tape	2000pcs/Box
PCR606	TO-92	Bulk	1000pcs/Bag
PCR606-TA	TO-92	Tape	2000pcs/Box

## ELECTRICAL CHARACTERISTICS

$T_a=25\text{ }^\circ\text{C}$  unless otherwise specified

Parameter	Symbol	Test conditions	Min	Max	Unit	
On state voltage	$V_{TM}$	$I_{TM}=0.6A$		1.7	V	
Gate trigger voltage	$V_{GT}$	$V_{AK}=7V$		0.8	V	
Repetitive peak off-state voltage	$V_{DRM}(PCR406)$	$I_{DRM}=10\mu A$	400		V	
	$V_{DRM}(PCR606)$		600		V	
Holding current	$I_H$	$I_{HL}=20\text{ mA}$ , $V_{AK}=7\text{ V}$		5	mA	
Gate trigger current	$I_{GT}$	$V_{AK}=7V$	A2	5	15	$\mu A$
			A1	15	40	$\mu A$
			A-1	40	60	$\mu A$
			A-2	60	80	$\mu A$
			B	80	120	$\mu A$

## TO-92 Package Outline Dimensions

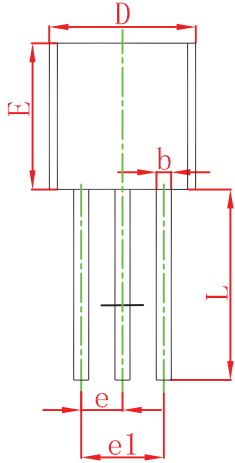
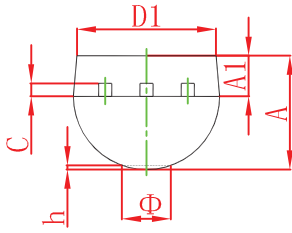

Symbol	Dimensions In Millimeters		Dimensions In Inches	
	Min	Max	Min	Max
A	3.300	3.700	0.130	0.146
A1	1.100	1.400	0.043	0.055
b	0.380	0.550	0.015	0.022
c	0.360	0.510	0.014	0.020
D	4.300	4.700	0.169	0.185
D1	3.430		0.135	
E	4.300	4.700	0.169	0.185
e	1.270 TYP		0.050 TYP	
e1	2.440	2.640	0.096	0.104
L	14.100	14.500	0.555	0.571
K		1.600		0.063
h	0.000	0.380	0.000	0.015

## TO-92 Suggested Pad Layout

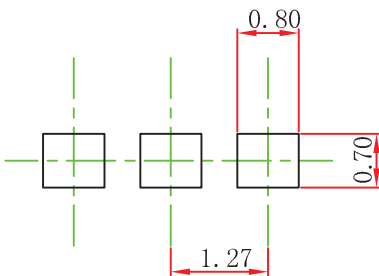

### Note:

1. Controlling dimension: in millimeters.
2. General tolerance:  $\pm 0.05$  mm.
3. The pad layout is for reference purposes only.

### NOTICE

JSCJ reserves the right to make modifications, enhancements, improvements, corrections or other changes without further notice to any product herein. JSCJ does not assume any liability arising out of the application or use of any product described herein.

TO-92 PACKAGE TAPEING DIMENSION

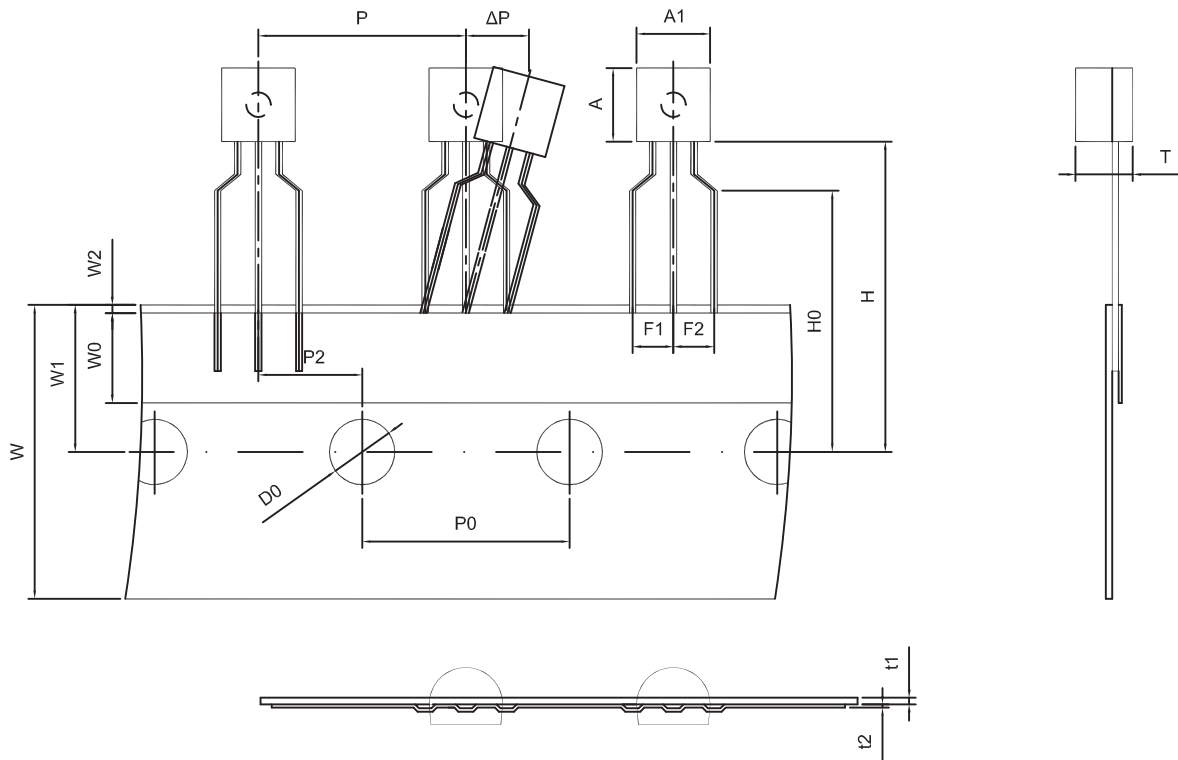

Dimiensions are in millimeter								
A1	A	T	P	P0	P2	F1	F2	W
4.5	4.5	3.5	12.7	12.7	6.35	2.5	2.5	18.0
W0	W1	W2	H	H0	D0	t1	t2	ΔP
6.0	9.0	1.0 MAX.	19.0	16.0	4.0	0.4	0.2	0

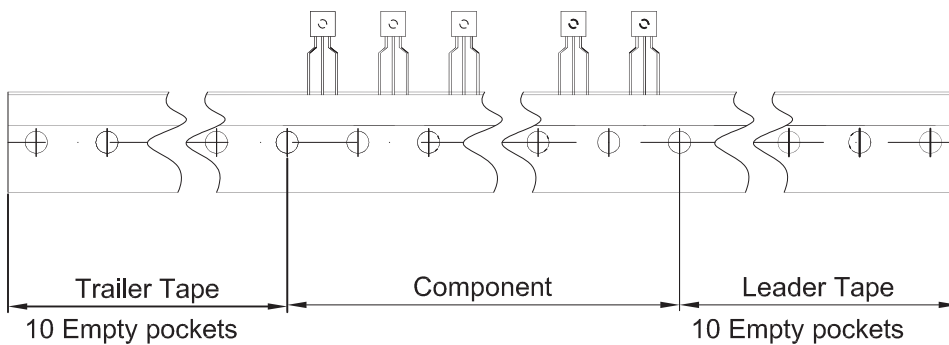

Package	Box	Box Size(mm)	Carton	Carton Size(mm)
TO-92	2000 pcs	333×162×43	20,000 pcs	350×340×250