



HARRIS HI-5040 thru HI-5051 HI-5046A and HI-5047A

January 1988

CMOS Analog Switches

HI-5040 thru HI-5051 HI-5046A and HI-5047A

Features

- Wide Analog Signal Range $\pm 15V$
- Low "ON" Resistance (Typical) 25Ω
- High Current Capability (Typical) $80mA$
- Break-Before-Make Switching
 - Turn-On Time (Typical) $370ns$
 - Turn-Off Time (Typical) $280ns$
- No Latch-Up
- Input MOS Gates Are Protected From Electrostatic Discharge
- DTL, TTL, CMOS, PMOS Compatible

Applications

- High Frequency Switching
- Sample and Hold
- Digital Filters
- Operational Amplifier Gain Switching

Description

This family of CMOS analog switches offers low-resistance switching performance for analog voltages up to the supply rails and for signal currents up to $80mA$. "ON" resistance is low and stays reasonably constant over the full range of operating signal voltage and current. R_{ON} remains exceptionally constant for input voltages between $+5V$ and $-5V$ and currents up to $50mA$. Switch impedance also changes very little over temperature, particularly between $0^\circ C$ and $+75^\circ C$. R_{ON} is nominally 25Ω for HI-5048 through HI-5051 and HI-5046A/5047A and 50Ω for HI-5040 through HI-5047.

All devices provide break-before-make switching and are TTL and CMOS compatible for maximum application versatility. Performance is further enhanced by Dielectric Isolation processing which insures latch-free operation with very low input and output leakage currents ($0.8nA$ at $+25^\circ C$). This family of switches also features very low power operation ($1.5mW$ at $+25^\circ C$).

There are 14 devices in this switch series which are differentiated by type of switch action and value of R_{ON} (see Functional Diagram). All devices are available in 16 pin DIP packages. The HI-5040/5050 switches can directly replace IH-5040 series devices except IH5048, and are functionally compatible with the DG 180/190 family. Each switch type is available in the $-55^\circ C$ to $+125^\circ C$ and $0^\circ C$ to $+75^\circ C$ performance grades.

Functional Description

PART NUMBER	TYPE	R_{ON}
HI-5040	SPST	75Ω
HI-5041	DUAL SPST	75Ω
HI-5042	SPDT	75Ω
HI-5043	DUAL SPDT	75Ω
HI-5044	DPST	75Ω
HI-5045	DUAL DPST	75Ω
HI-5046	DPDT	75Ω
HI-5046A	DPDT	25Ω
HI-5047	4PST	75Ω
HI-5047A	4PST	25Ω
HI-5048	DUAL SPST	25Ω
HI-5049	DUAL DPST	25Ω
HI-5050	SPDT	25Ω
HI-5051	DUAL SPDT	25Ω

Functional Diagram

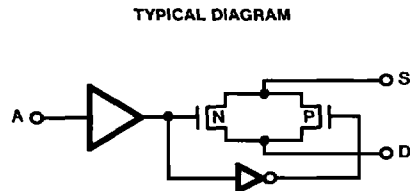

CAUTION: These devices are sensitive to electrostatic discharge. Proper I.C. handling procedures should be followed.
Copyright © Harris Corporation 1988

Specifications HI-5040 Series

HI-5040 thru HI-5051 HI-5046A and HI-5047A

Absolute Maximum Ratings

Supply Voltage (V+, V-)	36V
V _R to Ground	V+, V-
Digital and Analog Input Voltage	+V _{SUPPLY} +4V -V _{SUPPLY} -4V
Analog Current (S to D) Continuous	30mA
Analog Current (S to D) Peak	80mA
Total Power Dissipation*	450mW

Operating Temperature Range

HI-50XX-2	-55°C to +125°C
HI-50XX-5	0°C to +75°C
Storage Temperature	-65°C to +150°C

*Derate 6mW/°C Above T_A = +75°C

Electrical Specifications Unless Otherwise Specified Supplies = +15V, -15V; V_R = 0V; V_{AH} (Logic Level High) = 3.0V, V_{AL} (Logic Level Low) = +0.8V, V_L = +5V For Test Conditions, Consult Performance Characteristics, Unused Pins are Grounded.

PARAMETER	TEMP	-55°C To +125°C			0°C To +75°C			UNITS
		MIN	TYP	MAX	MIN	TYP	MAX	
ANALOG SWITCH CHARACTERISTICS								
Analogue Signal Range	Full	-15	-	+15	-15	-	+15	V
R _{ON} , On Resistance (Note 1a)	+25°C	-	50	-	-	50	-	Ω
R _{ON} , On Resistance (Note 1b)	Full	-	-	75	-	-	75	Ω
	+25°C	-	25	-	-	25	-	Ω
R _{ON} , Channel-to-Channel Match (Note 1a)	Full	-	-	50	-	-	50	Ω
	+25°C	-	2	10	-	2	10	Ω
R _{ON} , Channel-to-Channel Match (Note 1b)	Full	-	-	5	-	-	5	Ω
	+25°C	-	1	5	-	1	5	Ω
I _{S(OFF)} = I _{D(OFF)} , Off Input or Output Leakage Current	+25°C	-	0.8	-	-	0.8	-	nA
I _{D(ON)} , On Leakage Current	Full	-	100	500	-	100	500	nA
	+25°C	-	0.01	-	-	0.01	-	nA
	Full	-	-	500	-	-	500	nA
	+25°C	-	2	500	-	2	500	nA
DIGITAL INPUT CHARACTERISTICS								
V _{AL} , Input Low Threshold	Full	-	-	0.8	-	-	0.8	V
V _{AH} , Input High Threshold	Full	3.0	-	-	3.0	-	-	V
I _A , Input Leakage Current (High or Low)	Full	-	0.01	1.0	-	0.01	1.0	μA
SWITCHING CHARACTERISTICS								
t _{ON} , Switch On Time	+25°C	-	370	1000	-	370	1000	ns
t _{OFF} , Switch Off Time	+25°C	-	280	500	-	280	500	ns
Charge Injection (Note 2)	+25°C	-	5	20	-	5	-	mV
"Off Isolation" (Note 3)	+25°C	75	80	-	-	80	-	dB
"Crosstalk" (Note 3)	+25°C	80	88	-	-	88	-	dB
C _{S(OFF)} , Input Switch Capacitance	+25°C	-	11	-	-	11	-	pF
C _{D(OFF)} , } Output Switch Capacitance	+25°C	-	11	-	-	11	-	pF
	+25°C	-	22	-	-	22	-	pF
C _A , Digital Input Capacitance	+25°C	-	5	-	-	5	-	pF
C _{DS(OFF)} , Drain-To-Source Capacitance	+25°C	-	0.5	-	-	0.5	-	pF
POWER REQUIREMENTS								
P _D , Quiescent Power Dissipation	+25°C	-	1.5	-	-	1.5	-	mW
I ⁺ , +15V Quiescent Current	Full	-	-	0.3	-	-	0.5	mA
I ⁻ , -15V Quiescent Current	Full	-	-	0.3	-	-	0.5	mA
I _L , +5V Quiescent Current	Full	-	-	0.3	-	-	0.5	mA
I _R , Ground Quiescent Current	Full	-	-	0.3	-	-	0.5	mA

NOTES:

1. V_{OUT} = ±10V, I_{OUT} = 1mA
 - a). For HI-5040 thru HI-5047
 - b). For HI-5048 thru HI-5051, HI-5046A/5047A.
2. V_{IN} = 0V, C_L = 10,000pF.
3. R_L = 100Ω, f = 100kHz, V_{IN} = 2.0V_{p-p}, C_L = 5pF.

HI-5040 Series

HI-5040 thru HI-5051 HI-5046A and HI-5047A

Switch Functions SWITCH STATES ARE FOR LOGIC "1" INPUT

SPST
HI-5040 (75Ω)

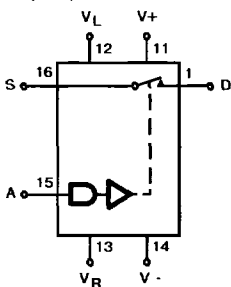

DUAL SPST
HI-5041 (75Ω)

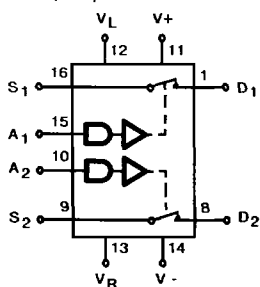

SPDT
HI-5042 (75Ω)

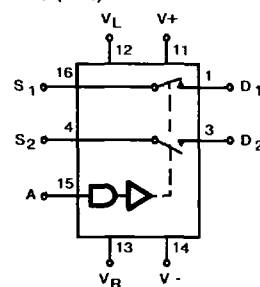

DUAL SPDT
HI-5043 (75Ω)

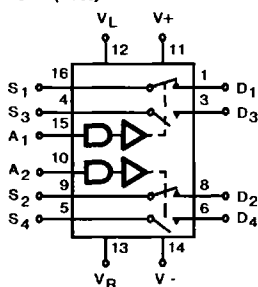

DPST
HI-5044 (75Ω)

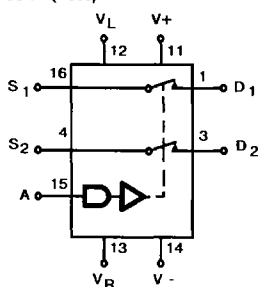

DUAL DPST
HI-5045 (75Ω)

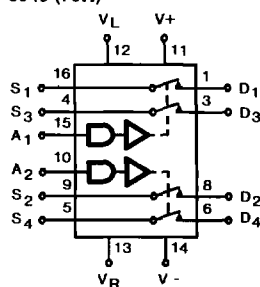

DPDT
HI-5046 (75Ω)
HI-5046A (25Ω)

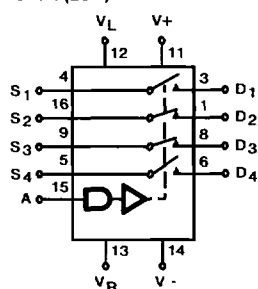

4PST
HI-5047 (75Ω)
HI-5047A (25Ω)

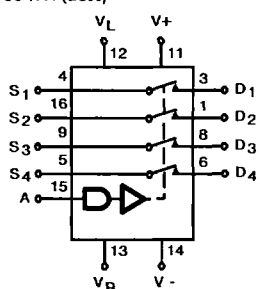

DUAL SPST
HI-5048 (25Ω)

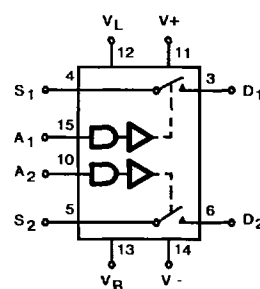

DUAL DPST
HI-5049 (25Ω)

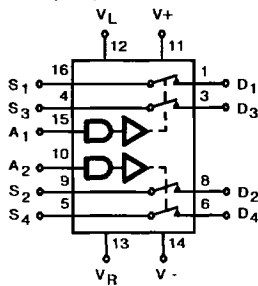

SPDT
HI-5050 (25Ω)

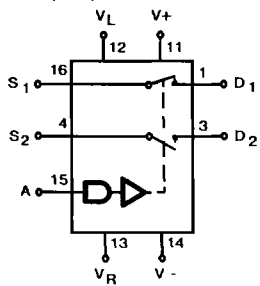

DUAL SPDT
HI-5051 (25Ω)

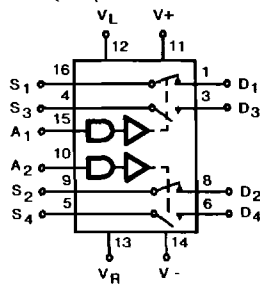

HI-5040 Series

Pin Configurations SWITCH STATES ARE FOR LOGIC "0" INPUT
SINGLE CONTROL

SPST
 HI-5040 (75Ω)

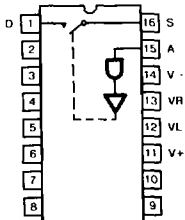

SPDT
 HI-5042 (75Ω)
 HI-5050 (25Ω)

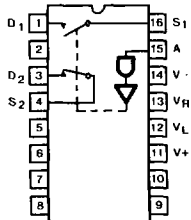

DPST
 HI-5044 (75Ω)

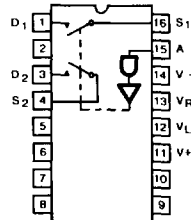

DPDT
 HI-5046 (75Ω)
 HI-5046A (25Ω)

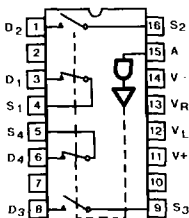

4PST
 HI-5047 (75Ω)
 HI-5047A (25Ω)

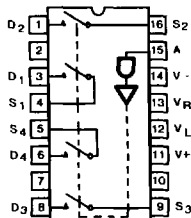

DUAL CONTROL
DUAL SPST
 HI-5041 (75Ω)

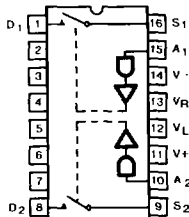

DUAL SPDT
 HI-5043 (75Ω)
 HI-5051 (25Ω)

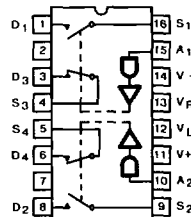

DUAL DPST
 HI-5045 (75Ω)
 HI-5049 (25Ω)

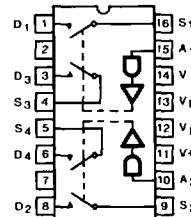

DUAL SPST
 HI-5048 (25Ω)

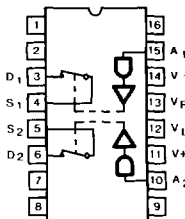

NOTE: Unused pins may be internally connected.
 Ground all unused pins.

HI-5040 thru HI-5051 HI-5046A and HI-5047A

HI-5040 Series

HI-5040 thru HI-5051 HI-5046A and HI-5047A

Performance Characteristics and Test Circuits

Unless Otherwise Specified: $T_A = +25^\circ\text{C}$, $V_+ = +15\text{V}$, $V_- = -15\text{V}$, $V_L = +5\text{V}$, $V_R = 0\text{V}$, $V_{AH} = 3.0\text{V}$ and $V_{AL} = 0.8\text{V}$

"ON" RESISTANCE vs. ANALOG SIGNAL LEVEL,
SUPPLY VOLTAGE AND TEMPERATURE

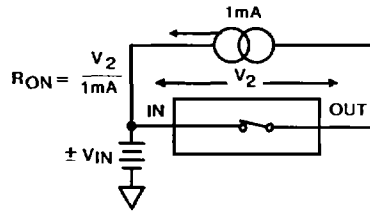

"ON" RESISTANCE vs. ANALOG SIGNAL LEVEL
AND POWER SUPPLY VOLTAGE

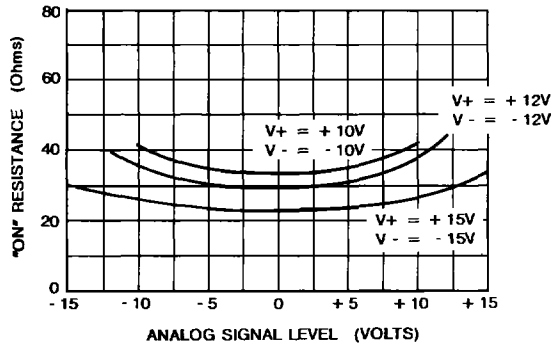

NORMALIZED "ON" RESISTANCE vs. TEMPERATURE

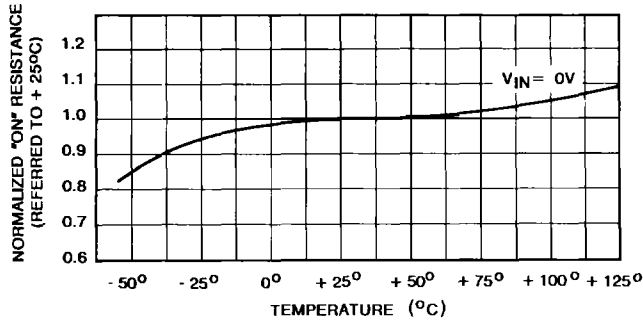

Performance Characteristics and Test Circuits (Continued)

ON/OFF LEAKAGE CURRENT vs. TEMPERATURE

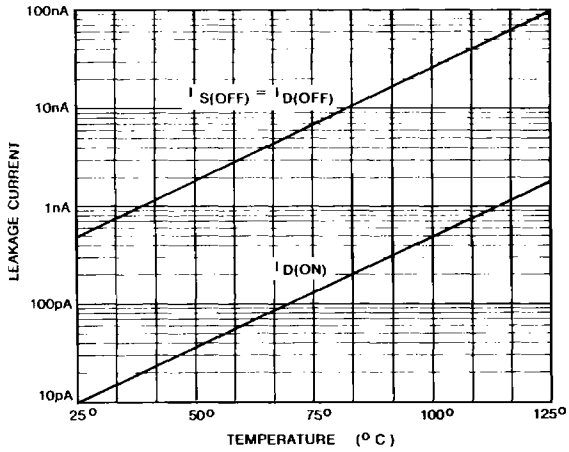

OFF LEAKAGE CURRENT vs. TEMPERATURE

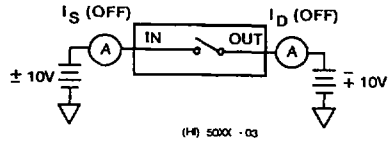

ON LEAKAGE CURRENT vs. TEMPERATURE

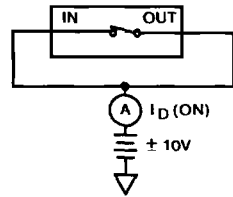

NORMALIZED "ON" RESISTANCE vs. ANALOG CURRENT

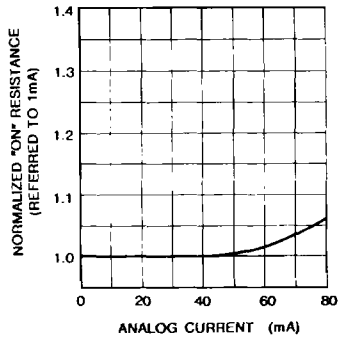

"ON" RESISTANCE vs. ANALOG CURRENT

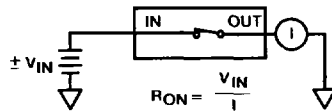

HI-5040 thru HI-5051 HI-5046A and HI-5047A

Performance Characteristics and Test Circuits (Continued)

"OFF" ISOLATION vs. FREQUENCY

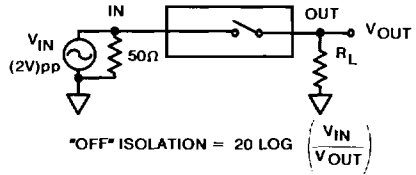
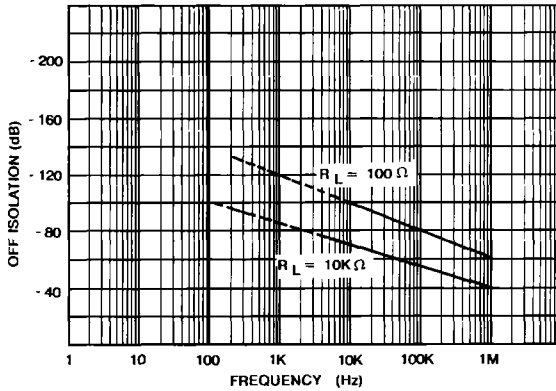

$$^{\circ}\text{"OFF" ISOLATION} = 20 \text{ LOG} \left(\frac{V_{IN}}{V_{OUT}} \right)$$

CROSSTALK vs. FREQUENCY

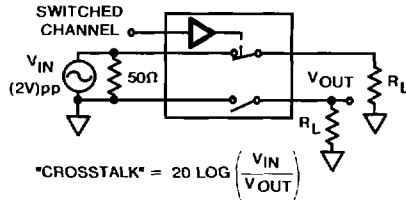
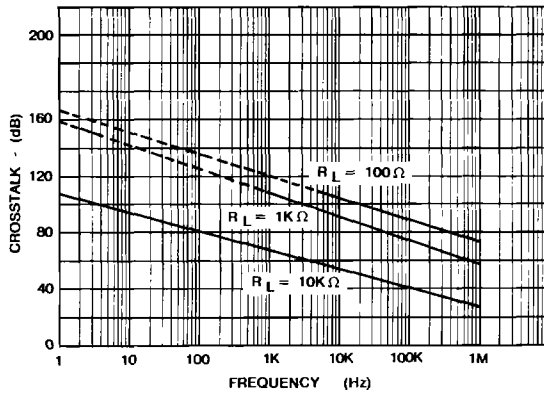

$$^{\circ}\text{CROSSTALK} = 20 \text{ LOG} \left(\frac{V_{IN}}{V_{OUT}} \right)$$

POWER CONSUMPTION vs. FREQUENCY

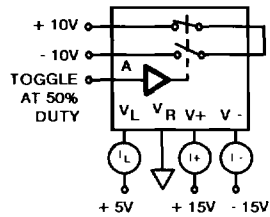
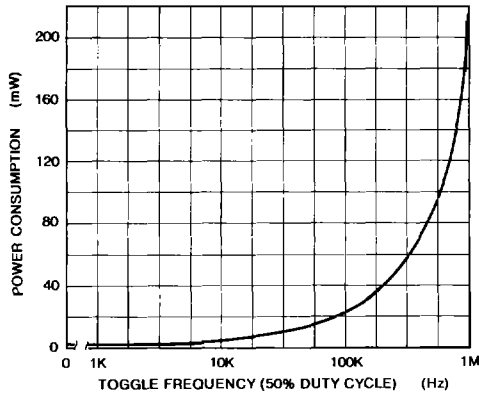

Switching Characteristics

ON/OFF SWITCH TIME vs. LOGIC LEVEL

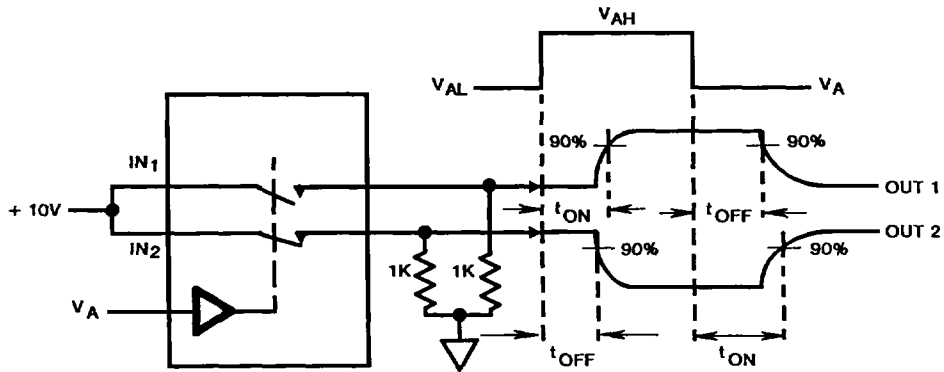

SWITCHING TIMES FOR POSITIVE DIGITAL TRANSITION

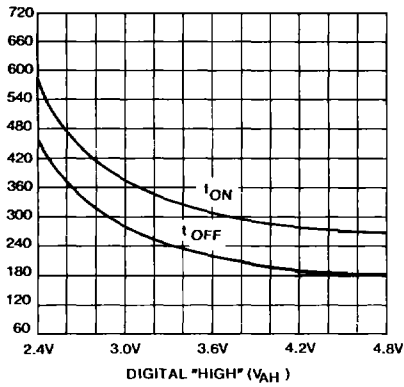

SWITCHING TIMES FOR NEGATIVE DIGITAL TRANSITION

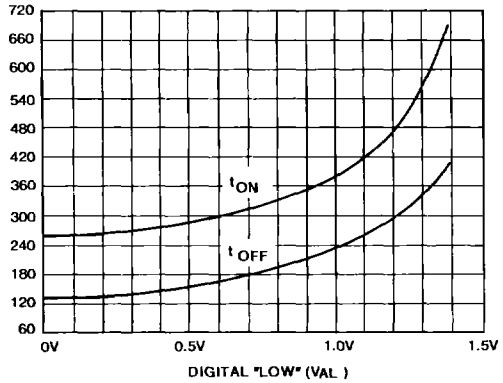

Switching Waveforms

Top: TTL Input (1V/Div.)
 V_{AH} = 3V, V_{AL} = 0.8V
 Bottom: Output (5V/Div.)
 Horizontal: 200ns/Div.

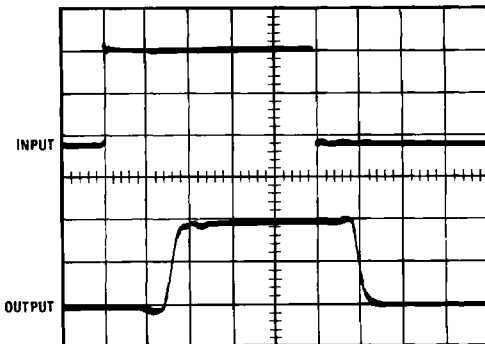

Top: CMOS Input (5V/Div.)
 V_{AH} = 10V, V_{AL} = 0V
 Bottom: Output (5V/Div.)
 Horizontal: 200ns/Div.

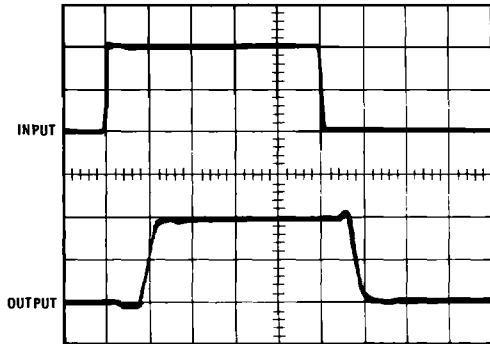

Switching Characteristics

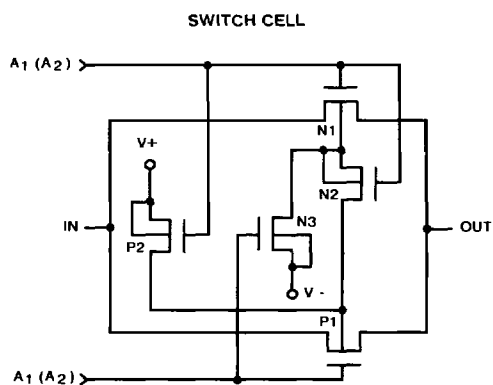
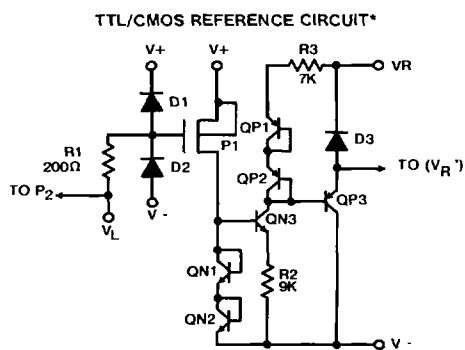

*Connect V+ to V_L for minimizing power consumption when driving from CMOS circuits

HI-5040 Series

DIGITAL INPUT BUFFER AND LEVEL SHIFTER

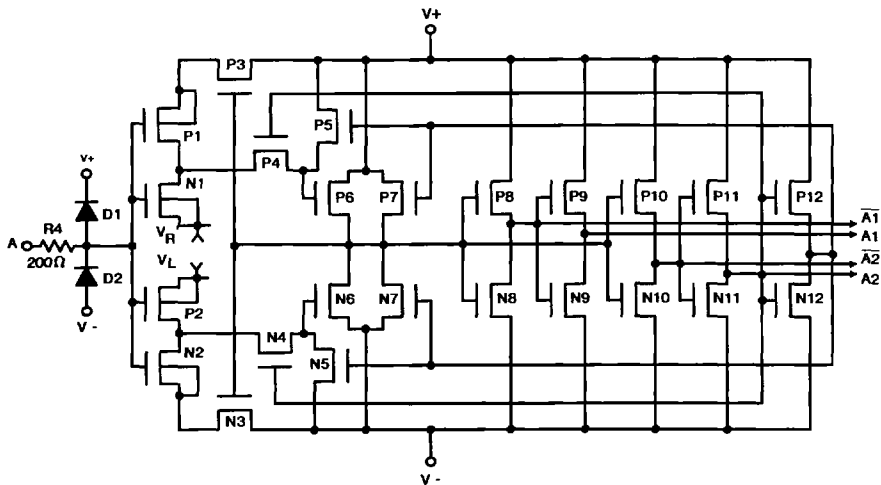

ALL N-CHANNEL
BODIES TO V-
ALL P-CHANNEL
BODIES TO V+
EXCEPT AS SHOWN

For Further Information Refer to Application Notes 520, 521, 531, 532, and 557 in Section 10 of Data Book.

HI-5040 thru HI-5051 HI-5046A and HI-5047A

HI-5040 Series

HI-5040 thru HI-5051 HI-5046A and HI-5047A

Ordering Information

PART NUMBER	TEMPERATURE RANGE	PACKAGE
HI1-5040-7	0°C to +75°C + 96 Hr. Burn-In	16-Pin CERDIP
HI3-5040-5	0°C to +75°C	16-Pin Plastic DIP
HI1-5040-2	-55°C to +125°C	16-Pin CERDIP
HI1-5040-5	0°C to +75°C	16-Pin CERDIP
HI3-5041-5	0°C to +75°C	16-Pin Plastic DIP
HI1-5041-5	0°C to +75°C	16-Pin CERDIP
HI1-5041-2	-55°C to +125°C	16-Pin CERDIP
HI1-5041-7	0°C to +75°C + 96 Hr. Burn-In	16-Pin CERDIP
HI3-5042-5	0°C to +75°C	16-Pin Plastic DIP
HI1-5042-5	0°C to +75°C	16-Pin CERDIP
HI1-5042-7	0°C to +75°C + 96 Hr. Burn-In	16-Pin CERDIP
HI1-5042-2	-55°C to +125°C	16-Pin CERDIP
HI1-5043-7	0°C to +75°C + 96 Hr. Burn-In	16-Pin CERDIP
HI4P5043-5	0°C to +75°C	20-Pin PLCC
HI1-5043-2	-55°C to +125°C	16-Pin CERDIP
HI3-5043-5	0°C to +75°C	16-Pin Plastic DIP
HI1-5043-5	0°C to +75°C	16-Pin CERDIP
HI1-5044-7	0°C to +75°C + 96 Hr. Burn-In	16-Pin CERDIP
HI1-5044-5	0°C to +75°C	16-Pin CERDIP
HI3-5044-5	0°C to +75°C	16-Pin Plastic DIP
HI1-5044-2	-55°C to +125°C	16-Pin CERDIP
HI1-5045-5	0°C to +75°C	16-Pin CERDIP
HI1-5045-7	0°C to +75°C + 96 Hr. Burn-In	16-Pin CERDIP
HI1-5045-2	-55°C to +125°C	16-Pin CERDIP
HI3-5045-5	0°C to +75°C	16-Pin Plastic DIP
HI4P5045-5	0°C to +75°C	20-Pin PLCC
HI1-5046-2	-55°C to +125°C	16-Pin CERDIP
HI1-5046-5	0°C to +75°C	16-Pin CERDIP
HI1-5046-7	0°C to +75°C + 96 Hr. Burn-In	16-Pin CERDIP
HI3-5046-5	0°C to +75°C	16-Pin Plastic DIP
HI1-5046A-7	0°C to +75°C + 96 Hr. Burn-In	16-Pin CERDIP
HI3-5046A-5	0°C to +75°C	16-Pin Plastic DIP
HI1-5046A-2	-55°C to +125°C	16-Pin CERDIP
HI1-5046A-5	0°C to +75°C	16-Pin CERDIP
HI1-5047-5	0°C to +75°C	16-Pin CERDIP
HI1-5047-7	0°C to +75°C + 96 Hr. Burn-In	16-Pin CERDIP
HI1-5047-2	-55°C to +125°C	16-Pin CERDIP
HI3-5047-5	0°C to +75°C	16-Pin Plastic DIP
HI1-5047A-5	0°C to +75°C	16-Pin CERDIP
HI1-5047A-2	-55°C to +125°C	16-Pin CERDIP
HI3-5047A-5	0°C to +75°C	16-Pin Plastic DIP
HI1-5047A-7	0°C to +75°C + 96 Hr. Burn-In	16-Pin CERDIP
HI1-5048-5	0°C to +75°C	16-Pin CERDIP
HI1-5048-7	0°C to +75°C + 96 Hr. Burn-In	16-Pin CERDIP
HI3-5048-5	0°C to +75°C	16-Pin Plastic DIP
HI1-5048-2	-55°C to +125°C	16-Pin CERDIP
HI4P5049-5	0°C to +75°C	20-Pin PLCC
HI1-5049-5	0°C to +75°C	16-Pin CERDIP
HI1-5049-2	-55°C to +125°C	16-Pin CERDIP
HI3-5049-5	0°C to +75°C	16-Pin Plastic DIP
HI1-5049-7	0°C to +75°C + 96 Hr. Burn-In	16-Pin CERDIP
HI1-5050-5	0°C to +75°C	16-Pin CERDIP
HI1-5050-2	-55°C to +125°C	16-Pin CERDIP
HI3-5050-5	0°C to +75°C	16-Pin Plastic DIP
HI1-5050-7	0°C to +75°C + 96 Hr. Burn-In	16-Pin CERDIP
HI1-5051-5	0°C to +75°C	16-Pin CERDIP
HI1-5051-2	-55°C to +125°C	16-Pin CERDIP
HI1-5051-7	0°C to +75°C + 96 Hr. Burn-In	16-Pin CERDIP
HI4P5051-5	0°C to +75°C	20-Pin PLCC
HI3-5051-5	0°C to +75°C	16-Pin Plastic DIP