

200 mA LDO with Ripple Blocker™ Technology

Features

- 1.8V to 3.6V Input Voltage Range
- Active Noise Rejection Over a Wide Frequency Band: >50 dB from 10 Hz to 10 MHz at 200 mA Load
- Rated to 200 mA Output Current
- Fixed Output Voltages
- Current-Limit and Thermal-Limit Protected
- 1.2 mm x 1.6 mm 4-Pin TDFN
- 5-Pin SOT-23
- Ultra-Small 0.88 mm x 0.88 mm WLCSP
- Logic-Controlled Enable Pin
- -40°C to +125°C Junction Temperature Range

Applications

- Smartphones/Smart Books
- Tablet PC/Notebooks and Webcams
- Digital Still and Video Cameras
- Global Positioning Systems
- Mobile Computing
- Automotive and Industrial Applications

General Description

The MIC94310 Ripple Blocker™ is a monolithic integrated circuit that provides low-frequency ripple attenuation (switching noise rejection) to a regulated output voltage. This is important for applications where a DC/DC switching converter is required to lower or raise a battery voltage, but where switching noise cannot be tolerated by sensitive downstream circuits such as in RF applications. The MIC94310 maintains high power supply ripple rejection (PSRR) with input voltages operating near the output voltage level to improve overall system efficiency. A low-voltage logic enable pin facilitates ON/OFF control at typical GPIO voltage levels.

The MIC94310 operates from an input voltage of 1.8V to 3.6V.

Packaged in a 4-pin 1.2 mm × 1.6 mm TDFN, a 5-pin SOT-23, or a 0.88 mm × 0.88 mm 4-Ball WLCSP, the MIC94310 has a junction operating temperature range of -40°C to +125°C.

Package Types

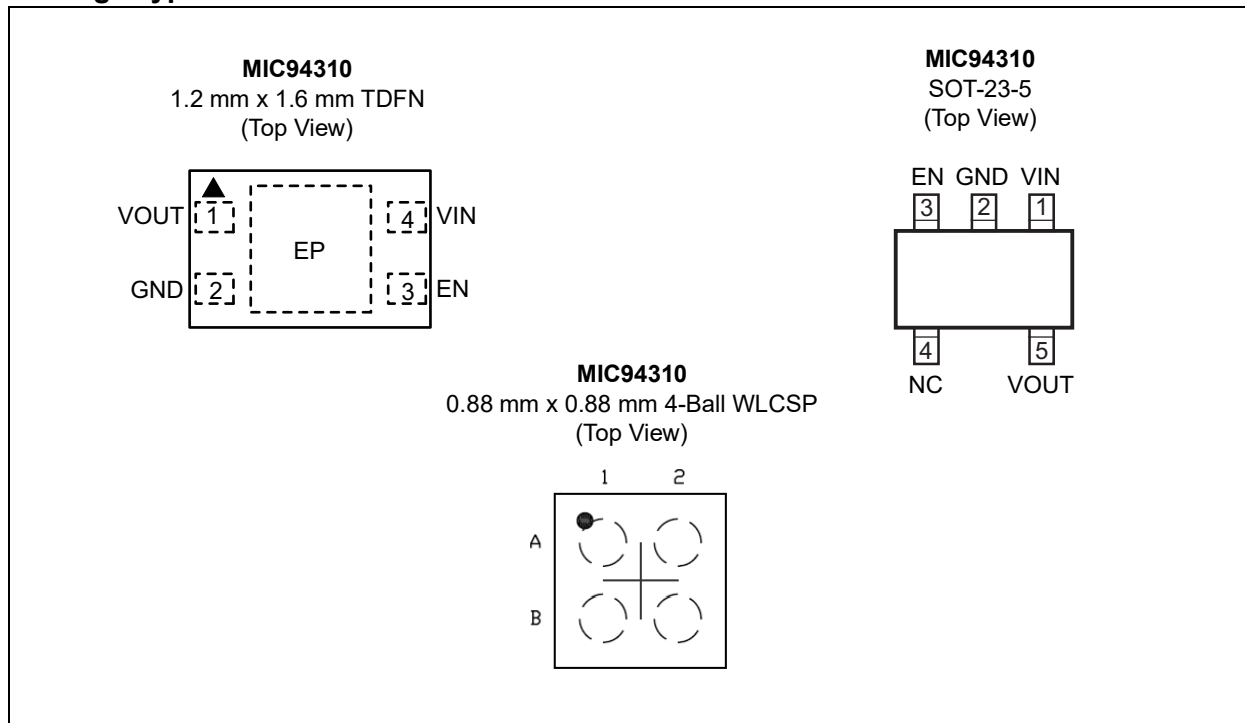

MIC94310

Typical Application Circuit

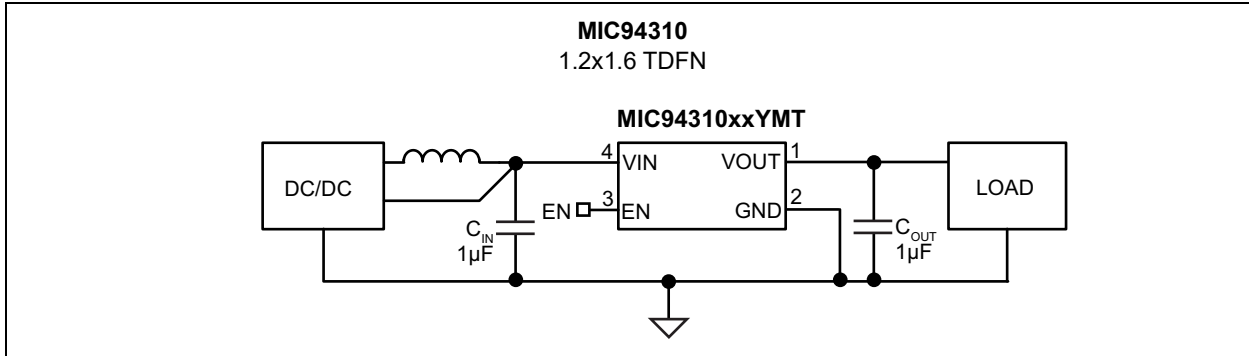

Functional Block Diagram

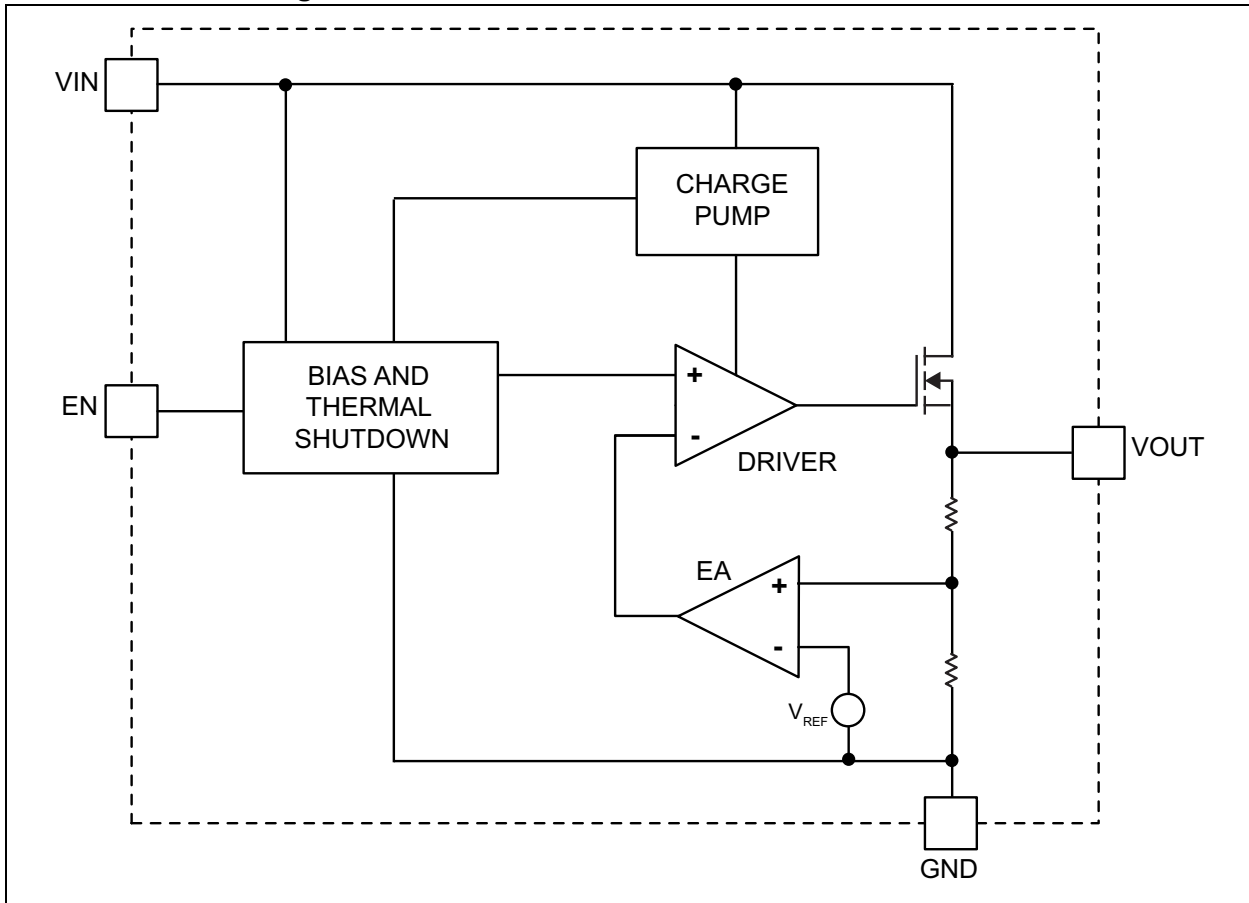

1.0 ELECTRICAL CHARACTERISTICS

Absolute Maximum Ratings †

Input Voltage, V_{IN}	-0.3V to +4.0V
Output Voltage, V_{OUT}	-0.3V to $V_{IN}+0.3V$ or +4.0V
Enable Voltage, V_{EN}	-0.3V to $V_{IN}+0.3V$ or +4.0V
ESD Rating (Note 1)	3 kV

Operating Ratings ††

Supply Voltage, V_{IN}	+1.8V to +3.6V
Enable Voltage, V_{EN}	0V to V_{IN}

† Notice: Exceeding the “Absolute Maximum Ratings †” may damage the device.

†† Notice: The device is not guaranteed to function outside its operating ratings.

Note 1: Devices are ESD-sensitive. Handling precautions are recommended. Human body model, 1.5 k Ω in series with 100 pF.

ELECTRICAL CHARACTERISTICS (Note 1)

Electrical Characteristics: Unless otherwise indicated, $V_{IN} = V_{EN} = V_{OUT} + 500$ mV ($V_{IN} = V_{EN} = 3.6$ V for $V_{OUT} \geq 3.1$ V); $I_{OUT} = 1$ mA; $C_{OUT} = 1$ μ F (YMT), $C_{OUT} = 10$ μ F (YM5); $T_A = 25^\circ$ C, **bold** values indicate -40° C $\leq T_J \leq +125^\circ$ C.

Parameters	Sym.	Min.	Typ.	Max.	Units	Conditions
Input Voltage	V_{IN}	1.8	—	3.6	V	—
Output Voltage Accuracy	V_{OUT}	-3	± 1	+3	%	Variation from nominal V_{OUT}
Dropout Voltage	V_{DO}	—	20	50	mV	V_{IN} to V_{OUT} dropout at 100 mA output current
		—	40	100	mV	V_{IN} to V_{OUT} dropout at 200 mA output current
Load Regulation	ΔV_{OUT}	—	4	—	mV	$I_{OUT} = 1$ mA to 100 mA
Line Regulation	$\Delta V_{OUT}/\Delta V_{IN}$	—	0.01	0.5	%	$V_{IN} = V_{OUT} + 500$ mV to 3.6V
Ground Current	I_{GND}	—	170	250	μ A	No load to full load
Shutdown Current	I_{SHDN}	—	0.2	5	μ A	$V_{EN} = 0$ V
V_{IN} Ripple Rejection	PSRR	—	85	—	dB	$f = 100$ Hz, $I_{OUT} = 100$ mA
		—	68	—	dB	$f = 100$ kHz, $I_{OUT} = 100$ mA
		—	57	—	dB	$f = 1$ MHz, $I_{OUT} = 100$ mA
		—	50	—	dB	$f = 10$ MHz, $I_{OUT} = 100$ mA
Current Limit	I_{LIM}	250	400	700	mA	$V_{OUT} = 0$ V
Total Output Noise	e_{no}	—	83	—	μ V _{RMS}	$f = 10$ Hz to 100 kHz
Turn-on Time	t_{ON}	—	70	—	μ s	—
Enable						
Input Logic Low Level	V_{EN_LOW}	—	—	0.4	V	—
Input Logic High Level	V_{EN_HIGH}	1.0	—	—	V	—
Enable Input Current	I_{EN}	—	0.01	1	μ A	—

Note 1: Specification for packaged product only.

MIC94310

TEMPERATURE SPECIFICATIONS

Parameters	Sym.	Min.	Typ.	Max.	Units	Conditions
Temperature Ranges						
Junction Operating Temperature	T_J	-40	—	+125	°C	—
Lead Temperature	—	—	—	+260	°C	Soldering, 10 sec.
Storage Temperature Range	T_S	-65	—	+150	°C	—
Package Thermal Resistances						
Thermal Resistance, TDFN	θ_{JA}	—	173	—	°C/W	—
Thermal Resistance, SOT-23-5Ld	θ_{JA}	—	120	—	°C/W	—
Thermal Resistance WLCSP	θ_{JA}	—	250	—	°C/W	—

Note 1: The maximum allowable power dissipation is a function of ambient temperature, the maximum allowable junction temperature and the thermal resistance from junction to air (i.e., T_A , T_J , θ_{JA}). Exceeding the maximum allowable power dissipation will cause the device operating junction temperature to exceed the maximum +125°C rating. Sustained junction temperatures above +125°C can impact the device reliability.

2.0 TYPICAL PERFORMANCE CURVES

Note: The graphs and tables provided following this note are a statistical summary based on a limited number of samples and are provided for informational purposes only. The performance characteristics listed herein are not tested or guaranteed. In some graphs or tables, the data presented may be outside the specified operating range (e.g., outside specified power supply range) and therefore outside the warranted range.

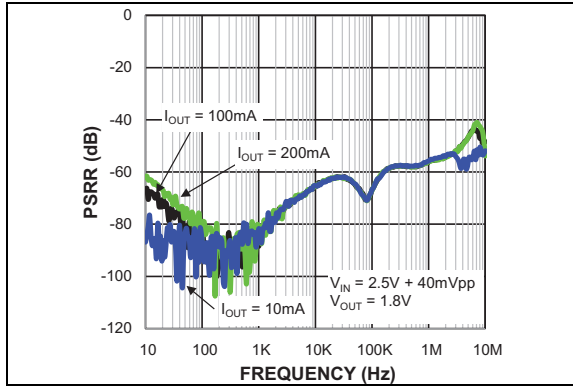

FIGURE 2-1: PSRR $C_{OUT} = 0.47 \mu F$.

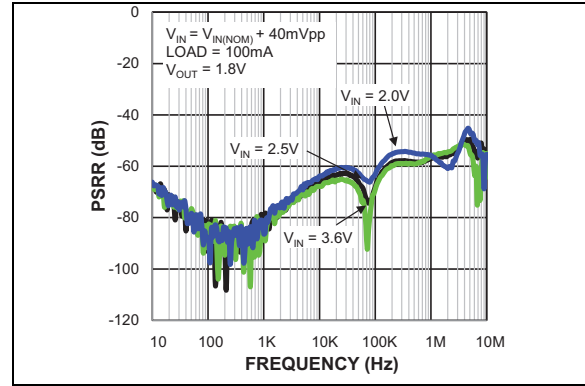

FIGURE 2-4: PSRR $C_{OUT} = 1 \mu F$.

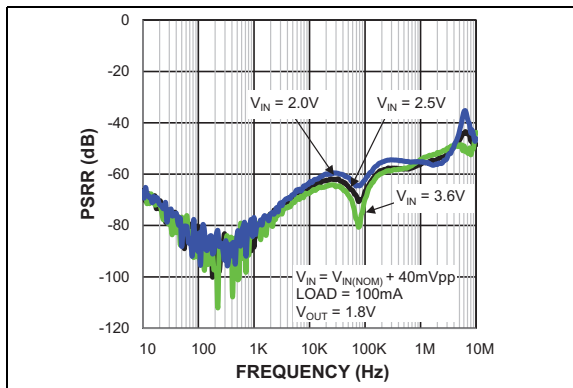

FIGURE 2-2: PSRR $C_{OUT} = 0.47 \mu F$.

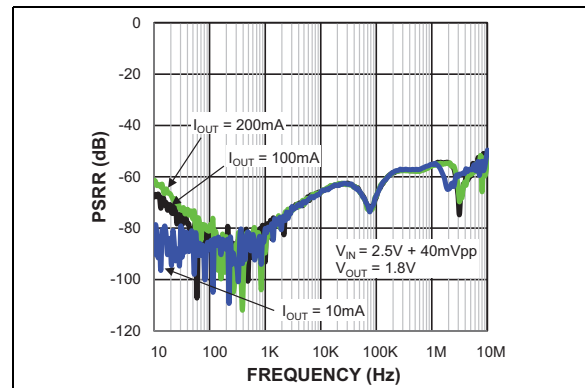

FIGURE 2-5: PSRR $C_{OUT} = 2.2 \mu F$.

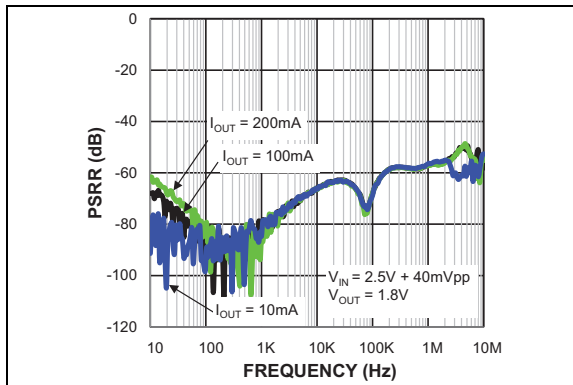

FIGURE 2-3: PSRR $C_{OUT} = 1 \mu F$.

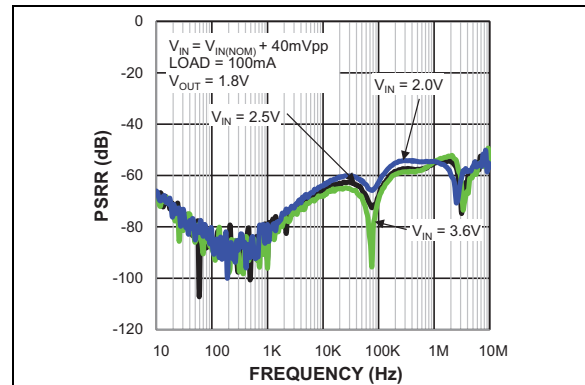

FIGURE 2-6: PSRR $C_{OUT} = 2.2 \mu F$.

MIC94310

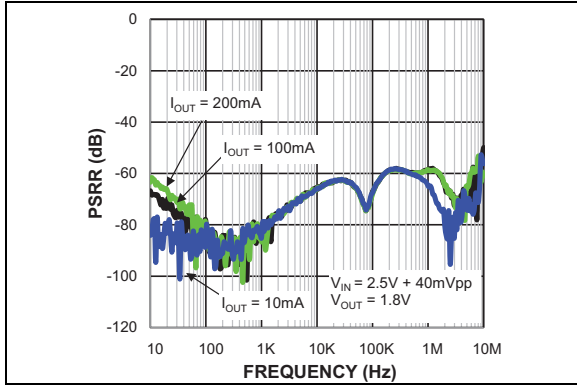

FIGURE 2-7: PSRR $C_{OUT} = 4.7 \mu F$.

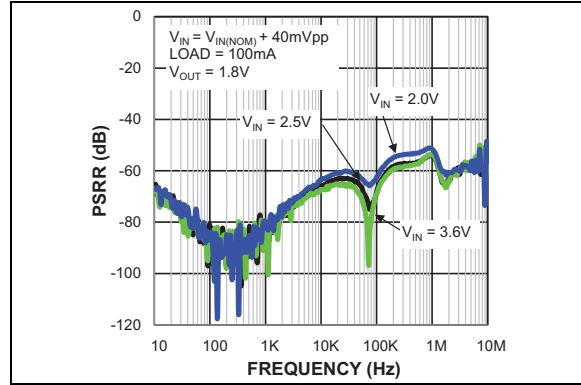

FIGURE 2-10: PSRR $C_{OUT} = 10 \mu F$.

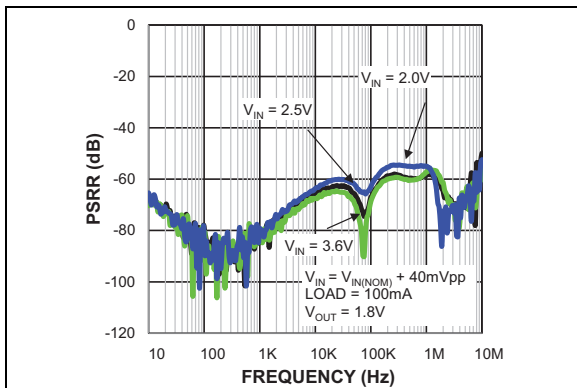

FIGURE 2-8: PSRR $C_{OUT} = 4.7 \mu F$.

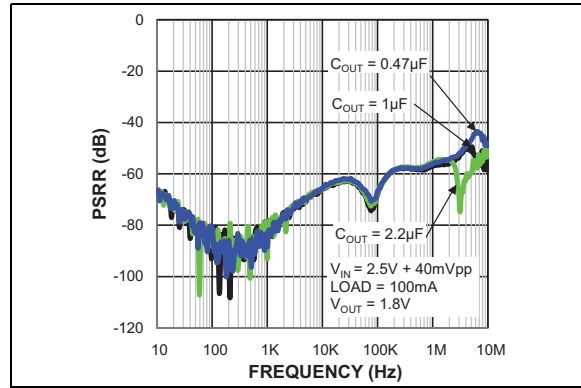

FIGURE 2-11: PSRR (Varying C_{OUT}).

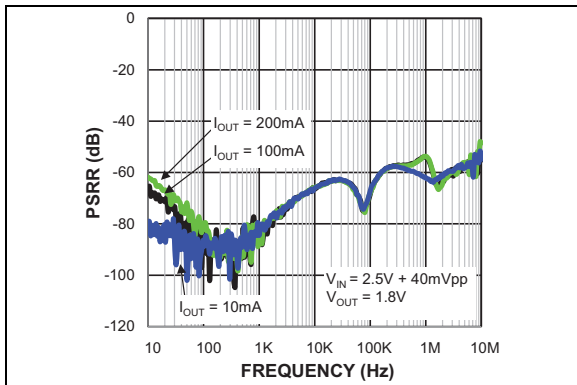

FIGURE 2-9: PSRR $C_{OUT} = 10 \mu F$.

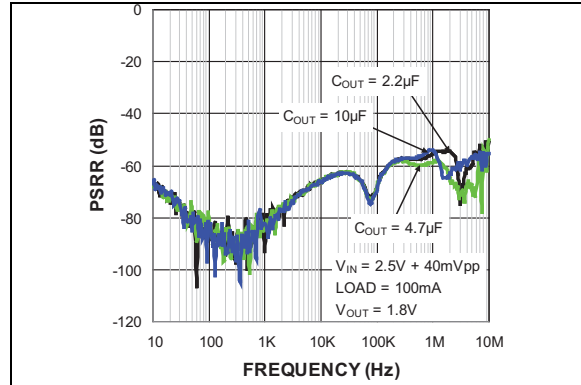

FIGURE 2-12: PSRR (Varying C_{OUT}).

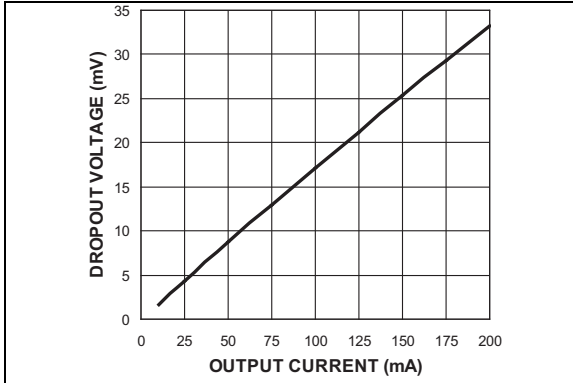

FIGURE 2-13: Drop Voltage vs. Output Current.

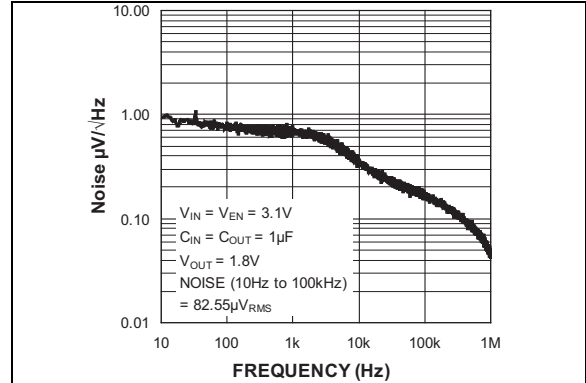

FIGURE 2-16: Output Noise Spectral Density.

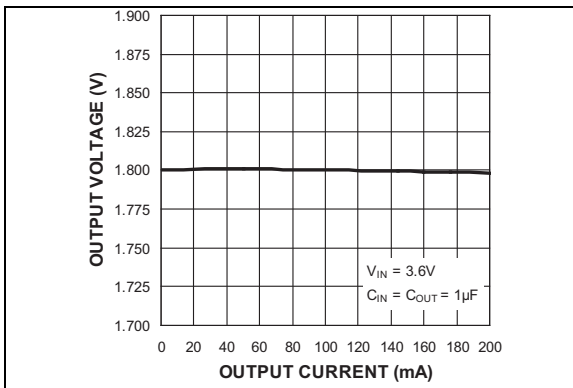

FIGURE 2-14: Output Voltage vs. Output Current.

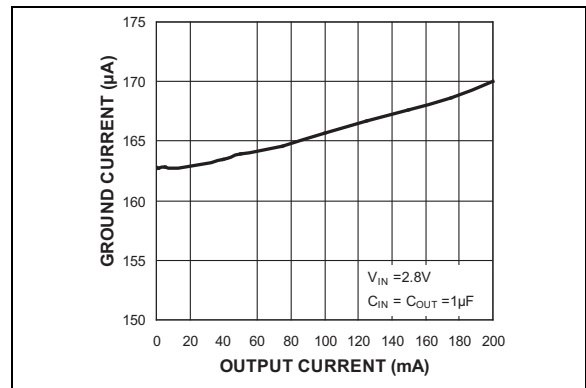

FIGURE 2-17: Ground Current vs. Output Current.

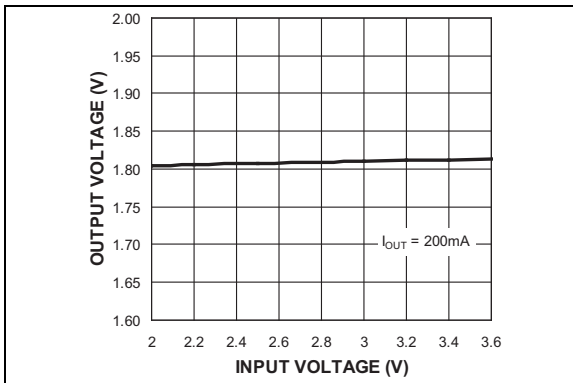

FIGURE 2-15: Output Voltage vs. Input Voltage.

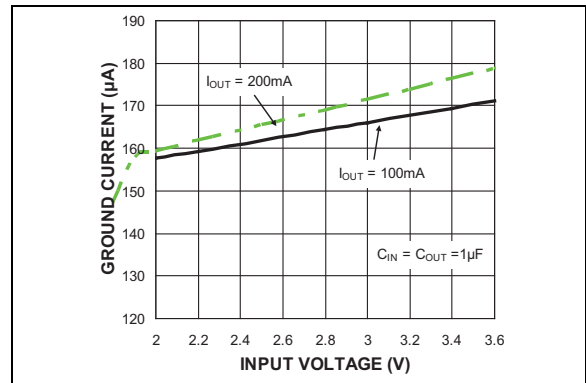

FIGURE 2-18: Ground Current vs. Input Voltage.

MIC94310

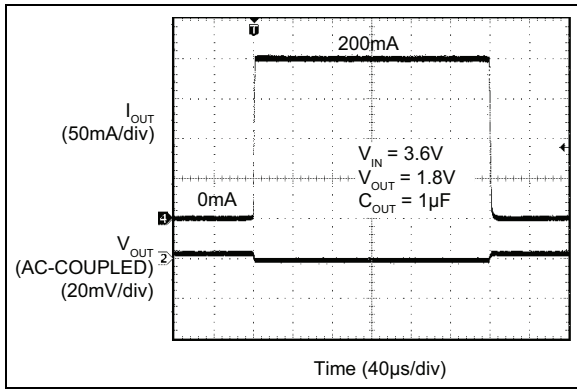

FIGURE 2-19: Load Transient (0 mA to 200 mA).

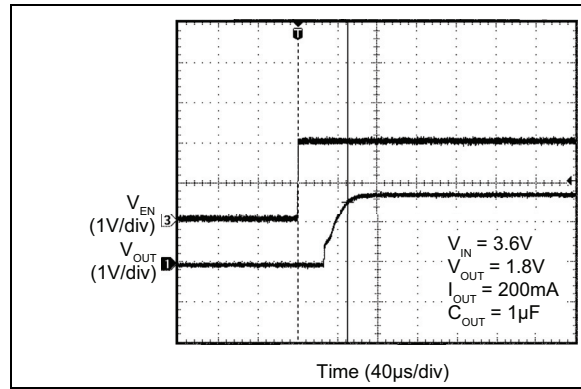

FIGURE 2-21: Enable Turn-On.

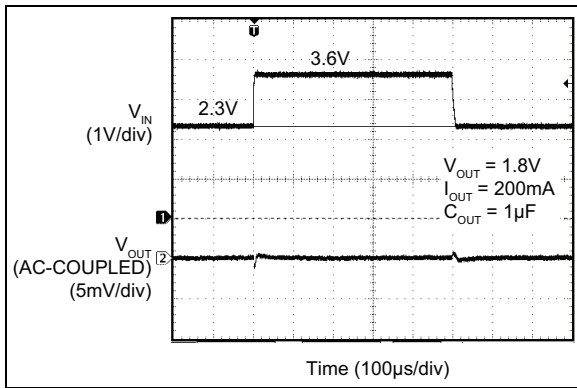

FIGURE 2-20: Line Transient (2.6V to 3.6V).

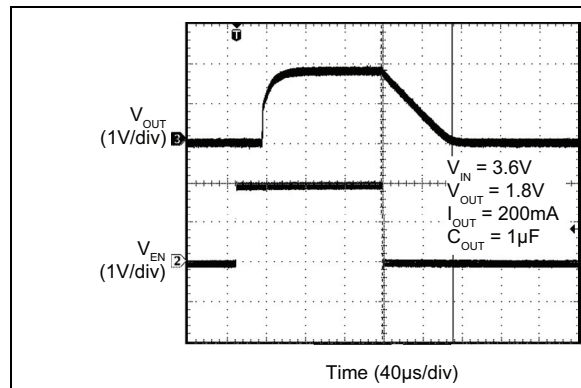

FIGURE 2-22: Enable Turn-Off.

3.0 PIN DESCRIPTIONS

The descriptions of the pins are listed in [Table 3-1](#).

TABLE 3-1: PIN FUNCTION TABLE

MIC94310 TDFN	MIC94310 SOT-23	MIC94310 WLCSP	Symbol	Description
1	5	A2	V_{OUT}	Power Switch Output
2	2	B2	GND	Ground
3	3	B1	EN	Enable Input A logic HIGH signal on this pin enables the part. Logic LOW disables the part. Do not leave floating.
4	1	A1	V_{IN}	Power switch input and chip supply
—	4	—	NC	No Connect, not internally connected
EP	—	—	EPAD	Exposed Heatsink Pad Connect to ground for best thermal performance.

MIC94310

4.0 APPLICATION INFORMATION

The MIC94310 is a very-high PSRR, fixed-output, 200 mA LDO utilizing Ripple Blocker technology. The MIC94310 is fully protected from damage due to fault conditions, offering linear current limiting and thermal shutdown.

4.1 Input Capacitor

The MIC94310 is a high-performance, high-bandwidth device. An input capacitor of 0.47 μF is required from the input to ground to provide stability. Low-ESR ceramic capacitors provide optimal performance at a minimum of space. Additional high-frequency capacitors, such as small-valued NPO dielectric-type capacitors, help filter out high-frequency noise and are good practice in any RF-based circuit. X5R or X7R dielectrics are recommended for the input capacitor. Y5V dielectrics lose most of their capacitance over temperature and are therefore, not recommended.

4.2 Output Capacitance

In order to maintain stability, the MIC94310 requires an output capacitor of 0.47 μF or greater for the Thin DFN package and 10 μF or greater for the SOT-23 package. For optimal ripple rejection performance, a 1 μF capacitor is recommended for the Thin DFN package. A 10 μF capacitor is recommended for the SOT-23 package. The design is optimized for use with low-ESR ceramic chip capacitors. High-ESR capacitors are not recommended because they may cause high-frequency oscillation. The output capacitor can be increased, but performance has been optimized for a 1 μF ceramic output capacitor and does not improve significantly with larger capacitance.

X7R/X5R dielectric type ceramic capacitors are recommended because of their temperature performance. X7R type capacitors change capacitance by 15% over their operating temperature range and are the most stable type of ceramic capacitors. Z5U and Y5V dielectric capacitors change their value by as much as 50% and 60%, respectively, over their operating temperature ranges. To use a ceramic chip capacitor with the Y5V dielectric, the value must be much higher than an X7R ceramic capacitor to ensure the same minimum capacitance over the equivalent operating temperature range.

4.3 No Load Stability

The MIC94310 will remain stable and in regulation with no load. This is especially important in CMOS RAM keep-alive applications.

4.4 Enable/Shutdown

Forcing the enable (EN) pin low disables the MIC94310 and sends it into a “zero” off mode current state. In this state, current consumed by the MIC94310 goes nearly to zero. Forcing EN high enables the output voltage. The EN pin uses CMOS technology and cannot be left floating as it could cause an indeterminate state on the output.

4.5 Thermal Considerations

The MIC94310 is designed to provide 200 mA of continuous current in a very small package. Maximum ambient operating temperature can be calculated based on the output current and the voltage drop across the part. For example if the input voltage is 2.5V, the output voltage is 1.8V, and the output current equals 200 mA. The actual power dissipation of the Ripple Blocker can be determined using [Equation 4-1](#):

EQUATION 4-1:

$$P_D = (V_{IN} - V_{OUT1})I_{OUT} + V_{IN}I_{GND}$$

Because this device is CMOS and the ground current is typically <170 μA over the load range, the power dissipation contributed by the ground current is <1% and can be ignored for the calculation shown in [Equation 4-2](#) and [Equation 4-3](#).

EQUATION 4-2:

$$P_D = (2.5V - 1.8V) \times 200 \text{ mA}$$

EQUATION 4-3:

$$P_D = 0.14W$$

To determine the maximum ambient operating temperature of the package, use the junction-to-ambient thermal resistance of the device and the [Equation 4-4](#):

EQUATION 4-4:

$$P_{D(MAX)} = \left(\frac{T_{J(MAX)} - T_A}{\theta_{JA}} \right)$$

$T_{J(MAX)} = 125^\circ\text{C}$, the maximum junction temperature of the die, θ_{JA} thermal resistance = 173 $^\circ\text{C}/\text{W}$ for the Thin DFN package.

Substituting P_D for $P_{D(MAX)}$ and solving for the ambient operating temperature will give the maximum operating conditions for the regulator circuit.

For proper operation, the maximum power dissipation must not be exceeded.

For example, when operating the MIC94310-GYMT at an input voltage of 2.5V and 200 mA load with a minimum footprint layout, the maximum ambient operating temperature (T_A) can be determined as follows:

EQUATION 4-5:

$$0.14 W = (125^{\circ}C - T_A) / (173^{\circ}C/W)$$

EQUATION 4-6:

$$T_A = 101^{\circ}C$$

Therefore, the maximum ambient operating temperature allowed in a 1.2 mm × 1.6 mm Thin DFN package is 101°C.

MIC94310

5.0 PACKAGING INFORMATION

5.1 Package Marking Information

5-lead SOT-23*

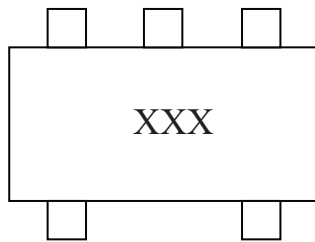

Example

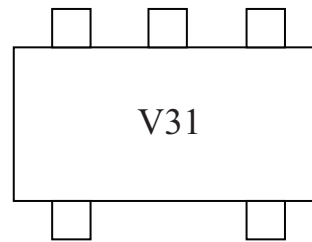

4-lead TDFN*

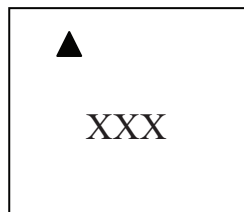

Example

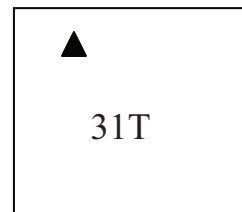

4-ball WLCSP*



Example

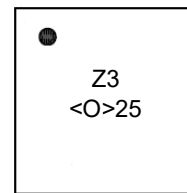

Legend:	XX...X	Product code or customer-specific information
	Y	Year code (last digit of calendar year)
	YY	Year code (last 2 digits of calendar year)
	WW	Week code (week of January 1 is week '01')
	NNN	Alphanumeric traceability code
	(e3)	Pb-free JEDEC® designator for Matte Tin (Sn)
	*	This package is Pb-free. The Pb-free JEDEC designator ((e3)) can be found on the outer packaging for this package.
	•, ▲, ▼	Pin one index is identified by a dot, delta up, or delta down (triangle mark).
Note:	In the event the full Microchip part number cannot be marked on one line, it will be carried over to the next line, thus limiting the number of available characters for customer-specific information. Package may or may not include the corporate logo.	
	Underbar (_) and/or Overbar (¯) symbol may not be to scale.	

4-Lead 1.2 mm × 1.6 mm Thin DFN Package Outline and Recommended Land Pattern

TITLE

4 LEAD TDFN 1.2x1.6mm PACKAGE OUTLINE & RECOMMENDED LAND PATTERN

DRAWING #	TDFN1216-4LD-PL-1	UNIT	MM
-----------	-------------------	------	----

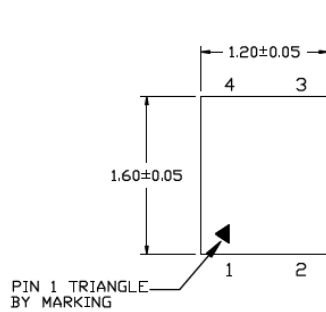

TOP VIEW

NOTE: 1, 2, 3

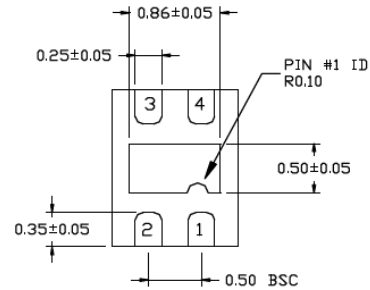

BOTTOM VIEW

NOTE: 1, 2, 3

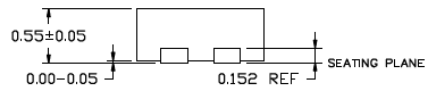

SIDE VIEW

NOTE: 1, 2, 3

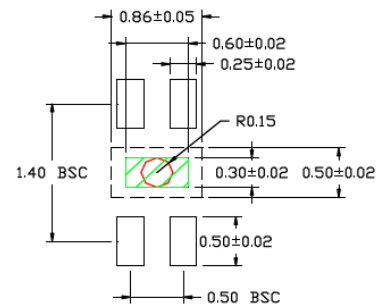

RECOMMENDED LAND PATTERN

NOTE: 4, 5

NOTE:

1. MAX PACKAGE WARPAGE IS 0.05mm.
2. MAX ALLOWABLE BURR IS 0.076mm IN ALL DIRECTIONS.
3. PIN #1 IS ON TOP WILL BE LASER MARKED.
4. GREEN SHADED AREA INDICATES SOLDER STENCIL OPENING (OPTIONAL) FOR IMPROVED THERMAL PERFORMANCE. RECOMMENDED SIZE IS 0.60mm x 0.30mm.
5. RED CIRCLE REPRESENTS THERMAL VIA & SHOULD BE CONNECTED TO GND FOR MAX PERFORMANCE. RECOMMENDED DIAMETER IS 0.30mm - 0.35mm.

Note: For the most current package drawings, please see the Microchip Packaging Specification located at <http://www.microchip.com/packaging>.

MIC94310

5-Pin SOT-23 Package Outline and Recommended Land Pattern

TITLE

5 LEAD SOT23 PACKAGE OUTLINE & RECOMMENDED LAND PATTERN

DRAWING #	SOT23-5LD-PL-1	UNIT	MM
-----------	----------------	------	----

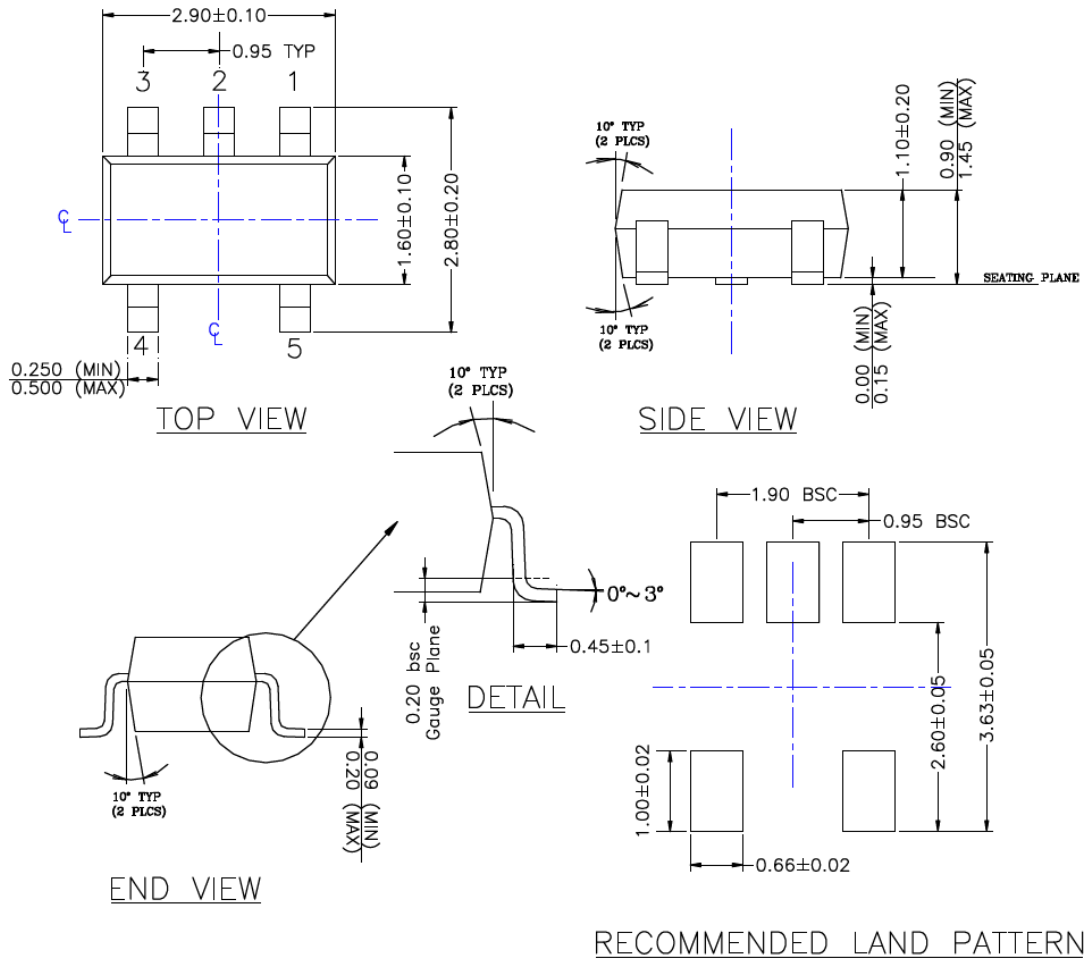

NOTE:

1. PACKAGE OUTLINE EXCLUSIVE OF MOLD FLASH & BURR.
2. PACKAGE OUTLINE INCLUSIVE OF SOLER PLATING.
3. DIMENSION AND TOLERANCE PER ANSI Y14.5M, 1982.
4. FOOT LENGTH MEASUREMENT BASED ON GAUGE PLANE METHOD.
5. DIE FACES UP FOR MOLD, AND FACES DOWN FOR TRIM/FORM.
6. ALL DIMENSIONS ARE IN MILLIMETERS.

Note: For the most current package drawings, please see the Microchip Packaging Specification located at <http://www.microchip.com/packaging>.

4-Ball WLCSP 0.88 mm x 0.88 mm Package Outline and Recommended Land Pattern

TITLE

4 BALL WLCSP 0.88x0.88mm PACKAGE OUTLINE & RECOMMENDED LAND PATTERN

DRAWING #	WLCSP088088D-4BL-PL-9	UNIT	MM
-----------	-----------------------	------	----

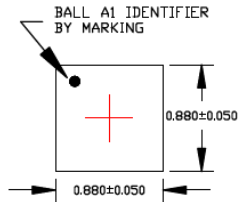

TOP VIEW

NOTE: 1,2

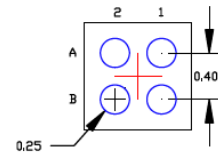

BOTTOM VIEW

NOTE: 1,2

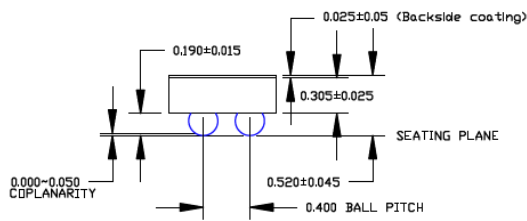

SIDE VIEW

NOTE: 1,2

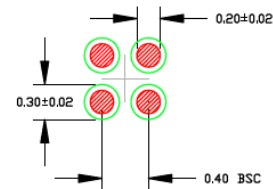

RECOMMENDED LAND PATTERN

NOTE: 3,4

NOTE:

1. MAX PACKAGE WARPAGE IS 0.05 MM
2. MAX ALLOWABLE BURR IS 0.076MM IN ALL DIRECTIONS
3. NON-SOLDERMASK DEFINED PADS ARE RECOMMENDED FOR BOARD LAYOUT
4. SHADED RED CIRCLES REPRESENT CONTACT PAD AREA. GREEN CIRCLES REPRESENT SOLDER MASK OPENING

Note: For the most current package drawings, please see the Microchip Packaging Specification located at <http://www.microchip.com/packaging>.

MIC94310

NOTES:

APPENDIX A: REVISION HISTORY

Revision B (September 2020)

- Added 0.88 mm × 0.88 mm 4-Ball WLCSP package.

Revision A (October 2018)

- Converted Micrel document MIC94310 to Microchip data sheet template DS20006105A.
- Minor grammatical text changes throughout.

MIC94310

NOTES:

PRODUCT IDENTIFICATION SYSTEM

To order or obtain information, e.g., on pricing or delivery, contact your local Microchip representative or sales office.

<u>PART NO.</u>	<u>-X</u>	<u>X</u>	<u>XX</u>	<u>-XX</u>	Examples:	
Device	Output Voltage	Temperature Range	Package	Media Type		
Device:	MIC94310:	200 mA LDO with Ripple Blocker™ Technology			a) MIC94310-4YMT-T5:	200 mA LDO with Ripple Blocker™ Technology, 1.2V Output Voltage, -40°C to +85°C Temperature Range, 5-Lead TDFN, 5,000/Reel
Output Voltage:	4 = 1.2V F = 1.5V G = 1.8V D = 1.85V J = 2.5V L = 2.7V M = 2.8V N = 2.85V P = 3.0V S = 3.3V				b) MIC94310-4YMT-TR:	200 mA LDO with Ripple Blocker™ Technology, 1.2V Output Voltage, -40°C to +85°C Temperature Range, 5-Lead TDFN, 5,000/Reel
Temperature Range:	Y = -40°C to +85°C E = -40°C to +125°C				c) MIC94310-4YM5-T5:	200 mA LDO with Ripple Blocker™ Technology, 1.2V Output Voltage, -40°C to +85°C Temperature Range, 5-Lead SOT-235,000/Reel
Packages:	MT = 4-Lead 1.2 mm × 1.6 mm Thin DFN M5 = 5-Lead SOT-23 CS = 4-Ball 0.88 mm × 0.88 mm WLCSP				d) MIC94310-4YM5-TR:	200 mA LDO with Ripple Blocker™ Technology, 1.2V Output Voltage, -40°C to +85°C Temperature Range, 5-Lead SOT-23, 5,000/Reel
Media Type:	TR = 3,000/Reel (SOT-23) TR = 5,000/Reel (TDFN) TR = 3,000/Reel (WLCSP) T5 = 500/Reel				e) MIC94310-4YMT-T5:	200 mA LDO with Ripple Blocker™ Technology, 1.2V Output Voltage, -40°C to +85°C Temperature Range, 5-Lead TDFN, 5,000/Reel
					f) MIC94310-4YMT-TR:	200 mA LDO with Ripple Blocker™ Technology, 1.2V Output Voltage, -40°C to +85°C Temperature Range, 5-Lead TDFN, 5,000/Reel
					g) MIC94310-4YM5-T5:	200 mA LDO with Ripple Blocker™ Technology, 1.2V Output Voltage, -40°C to +85°C Temperature Range, 5-Lead SOT-23 5,000/Reel
					h) MIC94310-4YM5-TR:	200 mA LDO with Ripple Blocker™ Technology, 1.2V Output Voltage, -40°C to +85°C Temperature Range, 5-Lead SOT-23, 5,000/Reel
					i) MIC94310-4YCS-TR:	200 mA LDO with Ripple Blocker™ Technology, 1.2 Output Voltage, -40°C to +125°C Extended Temperature Range, 4-Ball WLCSP 3,000/Reel
					j) MIC94310-GYCS-TR:	200 mA LDO with Ripple Blocker™ Technology, 1.8 Output Voltage, -40°C to +125°C Extended Temperature Range, 4-Ball WLCSP 3,000/Reel
					k) MIC94310-JYCS-TR:	200 mA LDO with Ripple Blocker™ Technology, 2.5 Output Voltage, -40°C to +125°C Extended Temperature Range, 4-Ball WLCSP 3,000/Reel
					l) MIC94310-MYCS-TR:	200 mA LDO with Ripple Blocker™ Technology, 2.8 Output Voltage, -40°C to +125°C Extended Temperature Range, 4-Ball WLCSP 3,000/Reel
					m) MIC94310-PYCS-TR:	200 mA LDO with Ripple Blocker™ Technology, 0.0 Output Voltage, -40°C to +125°C Extended Temperature Range, 4-Ball WLCSP 3,000/Reel
					n) MIC94310-SYCS-TR:	200 mA LDO with Ripple Blocker™ Technology, 3.3 Output Voltage, -40°C to +125°C Extended Temperature Range, 4-Ball WLCSP 3,000/Reel
Note 1:	Tape and Reel identifier only appears in the catalog part number description. This identifier is used for ordering purposes and is not printed on the device package. Check with your Microchip Sales Office for package availability with the Tape and Reel option.					

MIC94310

NOTES:

Note the following details of the code protection feature on Microchip devices:

- Microchip products meet the specifications contained in their particular Microchip Data Sheet.
- Microchip believes that its family of products is secure when used in the intended manner and under normal conditions.
- There are dishonest and possibly illegal methods being used in attempts to breach the code protection features of the Microchip devices. We believe that these methods require using the Microchip products in a manner outside the operating specifications contained in Microchip's Data Sheets. Attempts to breach these code protection features, most likely, cannot be accomplished without violating Microchip's intellectual property rights.
- Microchip is willing to work with any customer who is concerned about the integrity of its code.
- Neither Microchip nor any other semiconductor manufacturer can guarantee the security of its code. Code protection does not mean that we are guaranteeing the product is "unbreakable." Code protection is constantly evolving. We at Microchip are committed to continuously improving the code protection features of our products. Attempts to break Microchip's code protection feature may be a violation of the Digital Millennium Copyright Act. If such acts allow unauthorized access to your software or other copyrighted work, you may have a right to sue for relief under that Act.

Information contained in this publication is provided for the sole purpose of designing with and using Microchip products. Information regarding device applications and the like is provided only for your convenience and may be superseded by updates. It is your responsibility to ensure that your application meets with your specifications.

THIS INFORMATION IS PROVIDED BY MICROCHIP "AS IS". MICROCHIP MAKES NO REPRESENTATIONS OR WARRANTIES OF ANY KIND WHETHER EXPRESS OR IMPLIED, WRITTEN OR ORAL, STATUTORY OR OTHERWISE, RELATED TO THE INFORMATION INCLUDING BUT NOT LIMITED TO ANY IMPLIED WARRANTIES OF NON-INFRINGEMENT, MERCHANTABILITY, AND FITNESS FOR A PARTICULAR PURPOSE OR WARRANTIES RELATED TO ITS CONDITION, QUALITY, OR PERFORMANCE.

IN NO EVENT WILL MICROCHIP BE LIABLE FOR ANY INDIRECT, SPECIAL, PUNITIVE, INCIDENTAL OR CONSEQUENTIAL LOSS, DAMAGE, COST OR EXPENSE OF ANY KIND WHATSOEVER RELATED TO THE INFORMATION OR ITS USE, HOWEVER CAUSED, EVEN IF MICROCHIP HAS BEEN ADVISED OF THE POSSIBILITY OR THE DAMAGES ARE FORESEEABLE. TO THE FULLEST EXTENT ALLOWED BY LAW, MICROCHIP'S TOTAL LIABILITY ON ALL CLAIMS IN ANY WAY RELATED TO THE INFORMATION OR ITS USE WILL NOT EXCEED THE AMOUNT OF FEES, IF ANY, THAT YOU HAVE PAID DIRECTLY TO MICROCHIP FOR THE INFORMATION. Use of Microchip devices in life support and/or safety applications is entirely at the buyer's risk, and the buyer agrees to defend, indemnify and hold harmless Microchip from any and all damages, claims, suits, or expenses resulting from such use. No licenses are conveyed, implicitly or otherwise, under any Microchip intellectual property rights unless otherwise stated.

For information regarding Microchip's Quality Management Systems, please visit www.microchip.com/quality.

Trademarks

The Microchip name and logo, the Microchip logo, Adaptec, AnyRate, AVR, AVR logo, AVR Freaks, BesTime, BitCloud, chipKIT, chipKIT logo, CryptoMemory, CryptoRF, dsPIC, FlashFlex, flexPWR, HELDO, IGLoo, JukeBlox, KeeLoq, Klear, LANCheck, LinkMD, maXStylus, maXTouch, MediaLB, megaAVR, Microsemi, Microsemi logo, MOST, MOST logo, MPLAB, OptoLyzer, PackeTime, PIC, picoPower, PICSTART, PIC32 logo, PolarFire, Prochip Designer, QTouch, SAM-BA, SenGenuity, SpyNIC, SST, SST Logo, SuperFlash, Symmetricom, SyncServer, Tachyon, TempTrackr, TimeSource, tinyAVR, UNI/O, Vectron, and XMEGA are registered trademarks of Microchip Technology Incorporated in the U.S.A. and other countries.

APT, ClockWorks, The Embedded Control Solutions Company, EtherSynch, FlashTec, Hyper Speed Control, HyperLight Load, IntelliMOS, Libero, motorBench, mTouch, Powermite 3, Precision Edge, ProASIC, ProASIC Plus, ProASIC Plus logo, Quiet-Wire, SmartFusion, SyncWorld, Temux, TimeCesium, TimeHub, TimePictra, TimeProvider, Vite, WinPath, and ZL are registered trademarks of Microchip Technology Incorporated in the U.S.A.

Adjacent Key Suppression, AKS, Analog-for-the-Digital Age, Any Capacitor, AnyIn, AnyOut, BlueSky, BodyCom, CodeGuard, CryptoAuthentication, CryptoAutomotive, CryptoCompanion, CryptoController, dsPICDEM, dsPICDEM.net, Dynamic Average Matching, DAM, ECAN, EtherGREEN, In-Circuit Serial Programming, ICSP, INICnet, Inter-Chip Connectivity, JitterBlocker, KlearNet, KlearNet logo, memBrain, MIndi, MiWi, MPASM, MPF, MPLAB Certified logo, MPLIB, MPLINK, MultiTRAK, NetDetach, Omniscient Code Generation, PICDEM, PICDEM.net, PICkit, PICtail, PowerSmart, PureSilicon, QMatrix, REAL ICE, Ripple Blocker, SAM-ICE, Serial Quad I/O, SMART-I.S., SQR, SuperSwitcher, SuperSwitcher II, Total Endurance, TSHARC, USBCheck, VariSense, ViewSpan, WiperLock, Wireless DNA, and ZENA are trademarks of Microchip Technology Incorporated in the U.S.A. and other countries.

SQTP is a service mark of Microchip Technology Incorporated in the U.S.A.

The Adaptec logo, Frequency on Demand, Silicon Storage Technology, and Symmcom are registered trademarks of Microchip Technology Inc. in other countries.

GestIC is a registered trademark of Microchip Technology Germany II GmbH & Co. KG, a subsidiary of Microchip Technology Inc., in other countries.

All other trademarks mentioned herein are property of their respective companies.

© 2018-2020, Microchip Technology Incorporated, All Rights Reserved.

ISBN: 978-1-5224-6705-2



MICROCHIP

Worldwide Sales and Service

AMERICAS

Corporate Office
2355 West Chandler Blvd.
Chandler, AZ 85224-6199
Tel: 480-792-7200
Fax: 480-792-7277
Technical Support:
<http://www.microchip.com/support>
Web Address:
www.microchip.com

Atlanta

Duluth, GA
Tel: 678-957-9614
Fax: 678-957-1455

Austin, TX

Tel: 512-257-3370

Boston

Westborough, MA
Tel: 774-760-0087
Fax: 774-760-0088

Chicago

Itasca, IL
Tel: 630-285-0071
Fax: 630-285-0075

Dallas

Addison, TX
Tel: 972-818-7423
Fax: 972-818-2924

Detroit

Novi, MI
Tel: 248-848-4000

Houston, TX

Tel: 281-894-5983

Indianapolis

Noblesville, IN
Tel: 317-773-8323
Fax: 317-773-5453
Tel: 317-536-2380

Los Angeles

Mission Viejo, CA
Tel: 949-462-9523
Fax: 949-462-9608
Tel: 951-273-7800

Raleigh, NC

Tel: 919-844-7510

New York, NY

Tel: 631-435-6000

San Jose, CA

Tel: 408-735-9110
Tel: 408-436-4270

Canada - Toronto

Tel: 905-695-1980
Fax: 905-695-2078

ASIA/PACIFIC

Australia - Sydney
Tel: 61-2-9868-6733

China - Beijing
Tel: 86-10-8569-7000

China - Chengdu
Tel: 86-28-8665-5511

China - Chongqing
Tel: 86-23-8980-9588

China - Dongguan
Tel: 86-769-8702-9880

China - Guangzhou
Tel: 86-20-8755-8029

China - Hangzhou
Tel: 86-571-8792-8115

China - Hong Kong SAR
Tel: 852-2943-5100

China - Nanjing
Tel: 86-25-8473-2460

China - Qingdao
Tel: 86-532-8502-7355

China - Shanghai
Tel: 86-21-3326-8000

China - Shenyang
Tel: 86-24-2334-2829

China - Shenzhen
Tel: 86-755-8864-2200

China - Suzhou
Tel: 86-186-6233-1526

China - Wuhan
Tel: 86-27-5980-5300

China - Xian
Tel: 86-29-8833-7252

China - Xiamen
Tel: 86-592-2388138

China - Zhuhai
Tel: 86-756-3210040

ASIA/PACIFIC

India - Bangalore
Tel: 91-80-3090-4444

India - New Delhi
Tel: 91-11-4160-8631

India - Pune
Tel: 91-20-4121-0141

Japan - Osaka
Tel: 81-6-6152-7160

Japan - Tokyo
Tel: 81-3-6880-3770

Korea - Daegu
Tel: 82-53-744-4301

Korea - Seoul
Tel: 82-2-554-7200

Malaysia - Kuala Lumpur
Tel: 60-3-7651-7906

Malaysia - Penang
Tel: 60-4-227-8870

Philippines - Manila
Tel: 63-2-634-9065

Singapore
Tel: 65-6334-8870

Taiwan - Hsin Chu
Tel: 886-3-577-8366

Taiwan - Kaohsiung
Tel: 886-7-213-7830

Taiwan - Taipei
Tel: 886-2-2508-8600

Thailand - Bangkok
Tel: 66-2-694-1351

Vietnam - Ho Chi Minh
Tel: 84-28-5448-2100

EUROPE

Austria - Wels
Tel: 43-7242-2244-39
Fax: 43-7242-2244-393

Denmark - Copenhagen
Tel: 45-4485-5910
Fax: 45-4485-2829

Finland - Espoo
Tel: 358-9-4520-820

France - Paris
Tel: 33-1-69-53-63-20
Fax: 33-1-69-30-90-79

Germany - Garching
Tel: 49-8931-9700

Germany - Haan
Tel: 49-2129-3766400

Germany - Heilbronn
Tel: 49-7131-72400

Germany - Karlsruhe
Tel: 49-721-625370

Germany - Munich
Tel: 49-89-627-144-0
Fax: 49-89-627-144-44

Germany - Rosenheim
Tel: 49-8031-354-560

Israel - Ra'anana
Tel: 972-9-744-7705

Italy - Milan
Tel: 39-0331-742611
Fax: 39-0331-466781

Italy - Padova
Tel: 39-049-7625286

Netherlands - Drunen
Tel: 31-416-690399
Fax: 31-416-690340

Norway - Trondheim
Tel: 47-7288-4388

Poland - Warsaw
Tel: 48-22-3325737

Romania - Bucharest
Tel: 40-21-407-87-50

Spain - Madrid
Tel: 34-91-708-08-90
Fax: 34-91-708-08-91

Sweden - Gothenberg
Tel: 46-31-704-60-40

Sweden - Stockholm
Tel: 46-8-5090-4654

UK - Wokingham
Tel: 44-118-921-5800
Fax: 44-118-921-5820