



# N-Channel Depletion-Mode DMOS FET

## Features

- ▶ Free from secondary breakdown
- ▶ Low power drive requirement
- ▶ Ease of paralleling
- ▶ Excellent thermal stability
- ▶ Integral source-drain diode
- ▶ High input impedance and low  $C_{ISS}$
- ▶ ESD gate protection

## Applications

- ▶ Solid state relays
- ▶ Normally-on switches
- ▶ Converters
- ▶ Power supply circuits
- ▶ Constant current sources
- ▶ Input protection circuits

## General Description

The LND150 is a high voltage N-channel depletion mode (normally-on) transistor utilizing Supertex's lateral DMOS technology. The gate is ESD protected.

The LND150 is ideal for high voltage applications in the areas of normally-on switches, precision constant current sources, voltage ramp generation and amplification.

## Ordering Information

Part Number	Package Options	Packing
LND150K1-G	TO-236AB (SOT-23)	3000/Reel
LND150N3-G	TO-92	1000/Bag
LND150N3-G P002	TO-92	2000/Reel
LND150N3-G P003	TO-92	2000/Reel
LND150N3-G P005	TO-92	2000/Reel
LND150N3-G P013	TO-92	2000/Reel
LND150N3-G P014	TO-92	2000/Reel
LND150N8-G	TO-243AA (SOT-89)	2000/Reel

-G denotes a lead (Pb)-free / RoHS compliant package

## Product Summary

$BV_{DSX}/BV_{DGX}$ (V)	$R_{DS(ON)}$ (max)	$I_{DSS}$ (min)
500	1.0k $\Omega$	1.0mA

## Pin Configuration

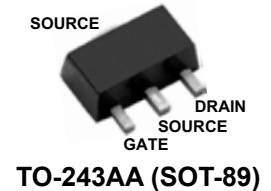
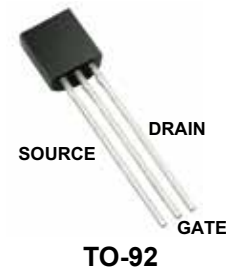

## Absolute Maximum Ratings

Parameter	Value
Drain-to-source	$BV_{DSX}$
Drain-to-gate	$BV_{DGX}$
Gate-to-source	$\pm 20V$
Operating and storage temperature	-55°C to +150°C

Absolute Maximum Ratings are those values beyond which damage to the device may occur. Functional operation under these conditions is not implied. Continuous operation of the device at the absolute rating level may affect device reliability. All voltages are referenced to device ground.

## Product Marking

**NDEW** W = Code for Week Sealed  
     = "Green" Packaging

**TO-236AB (SOT-23)**

**SiLN** YY = Year Sealed  
**D 1 5 0** WW = Week Sealed  
**YYWW**      = "Green" Packaging

**TO-92**

**LN1EW** W = Code for Week Sealed  
     = "Green" Packaging

**TO-243AA (SOT-89)**

Packages may or may not include the following marks: Si or

## Thermal Characteristics

Package	$I_D$ (continuous) <sup>†</sup> (mA)	$I_D$ (pulsed) (mA)	Power Dissipation @ $T_A = 25^\circ\text{C}$ (W)	$\theta_{ja}$ ( $^\circ\text{C}/\text{W}$ )	$I_{DR}$ (mA)	$I_{DRM}^{\dagger}$ (mA)
TO-236AB (SOT-23)	13	30	0.36	203	13	30
TO-92	30	30	0.74	132	30	30
TO-243AA (SOT-89)	30	30	1.6 <sup>‡</sup>	133	30	30

**Notes:**

<sup>†</sup>  $I_D$  (continuous) is limited by max rated  $T_j$ .

## Electrical Characteristics ( $T_A = 25^\circ\text{C}$ unless otherwise specified)

Sym	Parameter	Min	Typ	Max	Units	Conditions
$BV_{DSX}$	Drain-to-source breakdown voltage	500	-	-	V	$V_{GS} = -10\text{V}, I_D = 1.0\text{mA}$
$V_{GS(OFF)}$	Gate-to-source off voltage	-1.0	-	-3.0	V	$V_{GS} = 25\text{V}, I_D = 100\text{nA}$
$\Delta V_{GS(OFF)}$	Change in $V_{GS(OFF)}$ with temperature	-	-	5.0	mV/ $^\circ\text{C}$	$V_{GS} = 25\text{V}, I_D = 100\text{nA}$
$I_{GSS}$	Gate body leakage current	-	-	100	nA	$V_{GS} = \pm 20\text{V}, V_{DS} = 0\text{V}$
$I_{D(OFF)}$	Drain-to-source leakage current	-	-	100	nA	$V_{GS} = -10\text{V}, V_{DS} = 450\text{V}$
		-	-	100	$\mu\text{A}$	$V_{DS} = 0.8\text{V Max Rating}, V_{GS} = -10\text{V}, T_A = 125^\circ\text{C}$
$I_{DSS}$	Saturated drain-to-source current	1.0	-	3.0	mA	$V_{GS} = 0\text{V}, V_{DS} = 25\text{V}$
$R_{DS(ON)}$	Static drain-to-source on-state resistance	-	850	1000	$\Omega$	$V_{GS} = 0\text{V}, I_D = 0.5\text{mA}$
$\Delta R_{DS(ON)}$	Change in $R_{DS(ON)}$ with temperature	-	-	1.2	%/ $^\circ\text{C}$	$V_{GS} = 0\text{V}, I_D = 0.5\text{mA}$
$G_{FS}$	Forward transductance	1.0	2.0	-	m $\bar{\Omega}$	$V_{DS} = 0\text{V}, I_D = 1.0\text{mA}$
$C_{ISS}$	Input capacitance	-	7.5	10	pF	$V_{GS} = -10\text{V}, V_{DS} = 25\text{V}, f = 1.0\text{MHz}$
$C_{OSS}$	Common source output capacitance	-	2.0	3.5		
$C_{RSS}$	Reverse transfer capacitance	-	0.5	1.0		
$t_{d(ON)}$	Turn-on delay time	-	0.09	-	$\mu\text{s}$	$V_{DD} = 25\text{V}, I_D = 1.0\text{mA}, R_{GEN} = 25\Omega$
$t_r$	Rise time	-	0.45	-		
$t_{d(OFF)}$	Turn-off delay time	-	0.1	-		
$t_f$	Fall time	-	1.3	-		
$V_{SD}$	Diode forward voltage drop	-	-	0.9	V	$V_{GS} = -10\text{V}, I_{SD} = 1.0\text{mA}$
$t_{rr}$	Reverse recovery time	-	200	-	ns	$V_{GS} = -10\text{V}, I_{SD} = 1.0\text{mA}$

**Notes:**

1. All D.C. parameters 100% tested at  $25^\circ\text{C}$  unless otherwise stated. (Pulse test: 300 $\mu\text{s}$  pulse, 2% duty cycle.)
2. All A.C. parameters sample tested.

## Switching Waveforms and Test Circuit

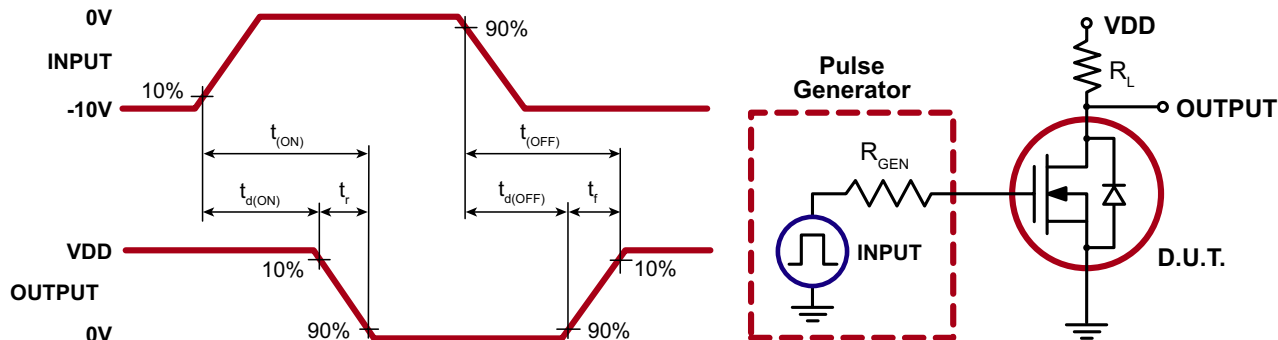

# Typical Performance Curves

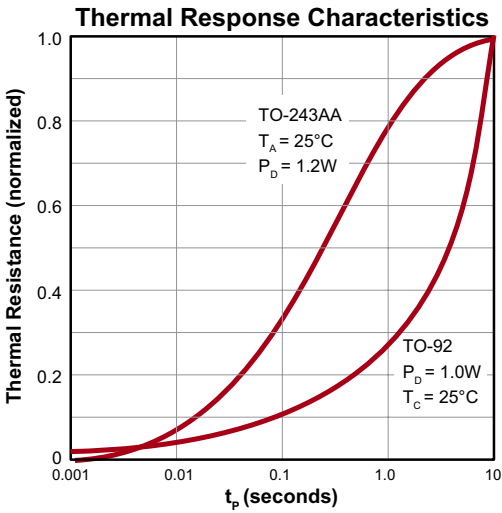
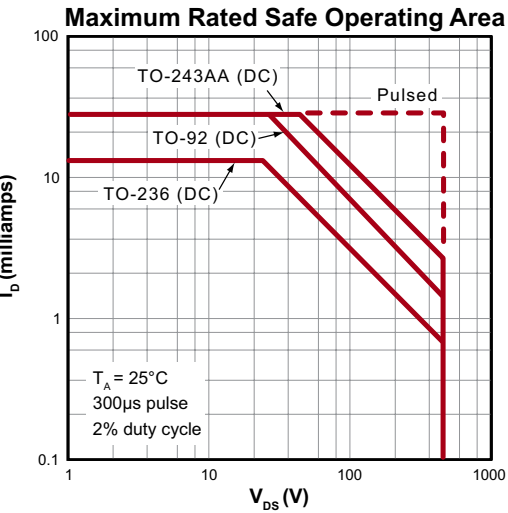
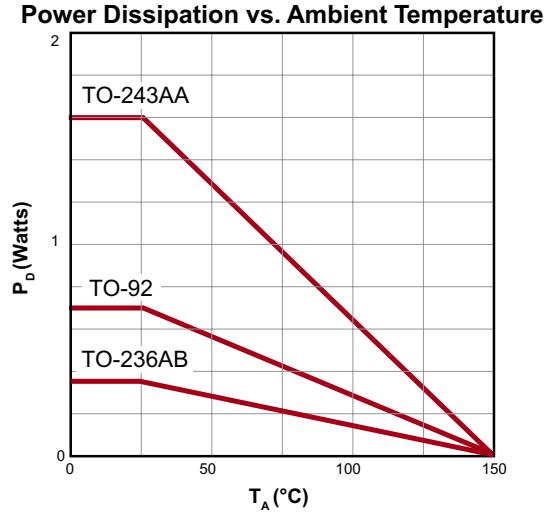
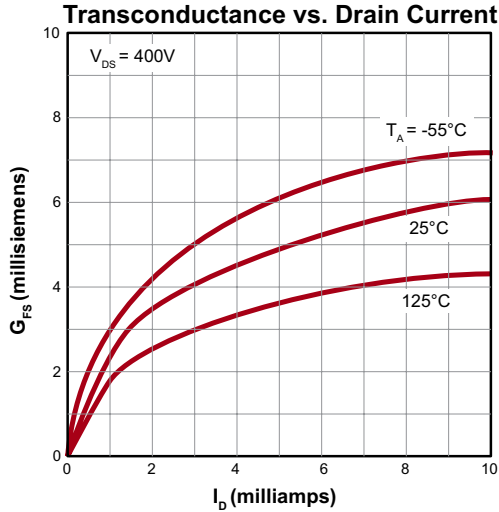
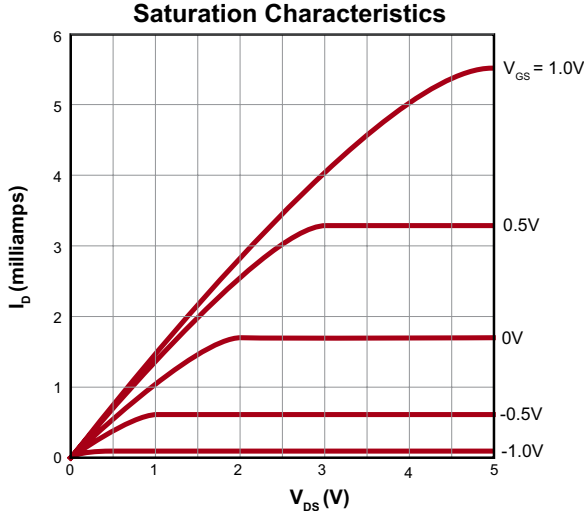
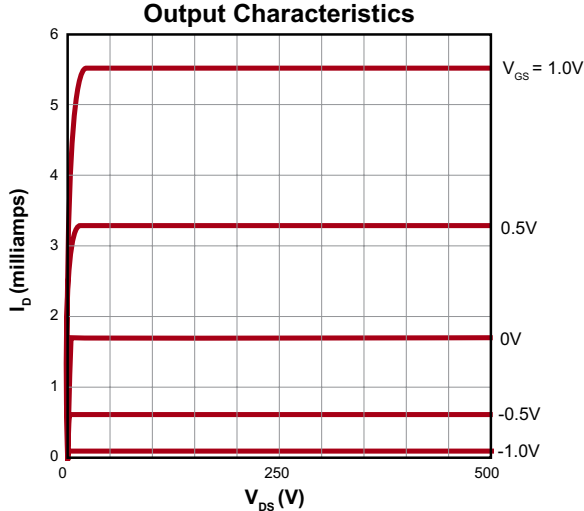

Typical Performance Curves (cont.)

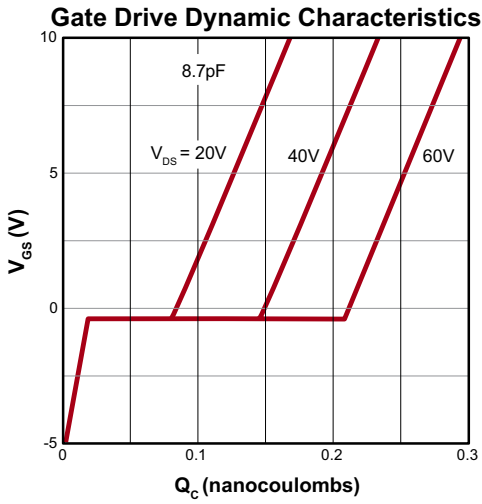
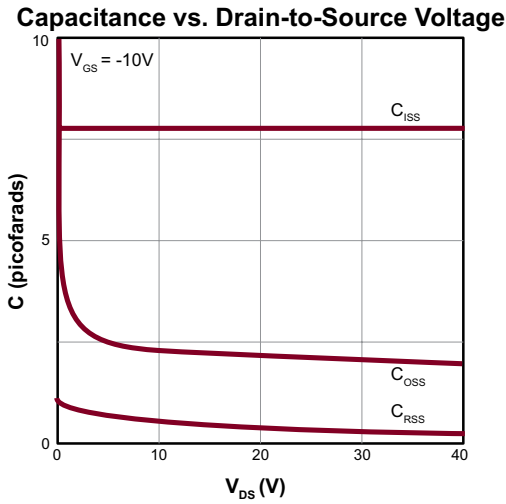
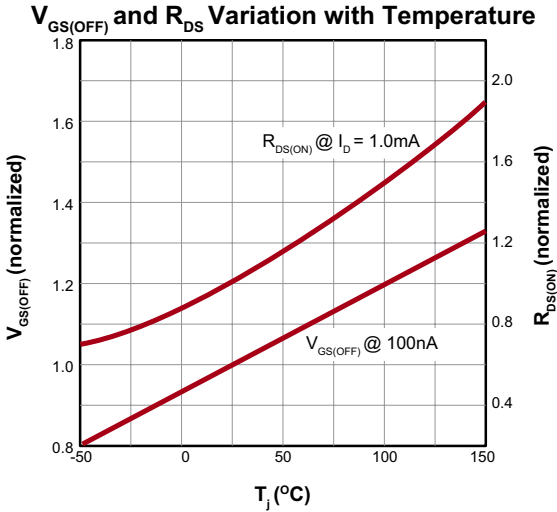
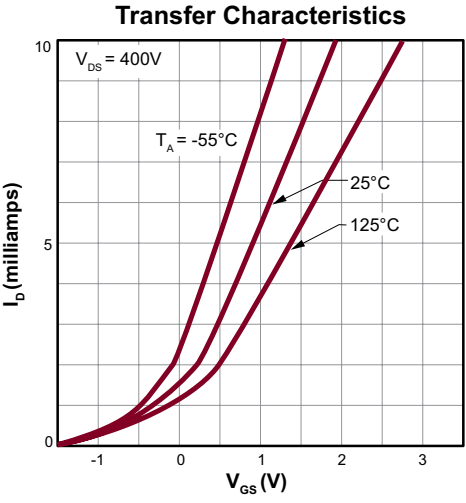
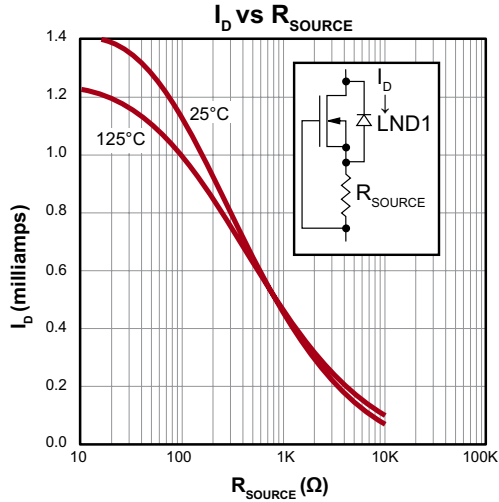
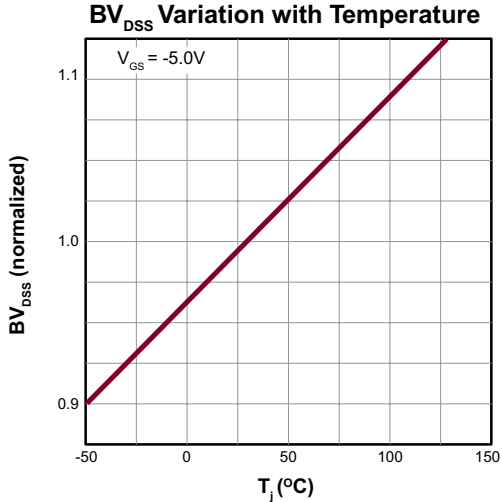

### 3-Lead TO-236AB (SOT-23) Package Outline (K1)

2.90x1.30mm body, 1.12mm height (max), 1.90mm pitch

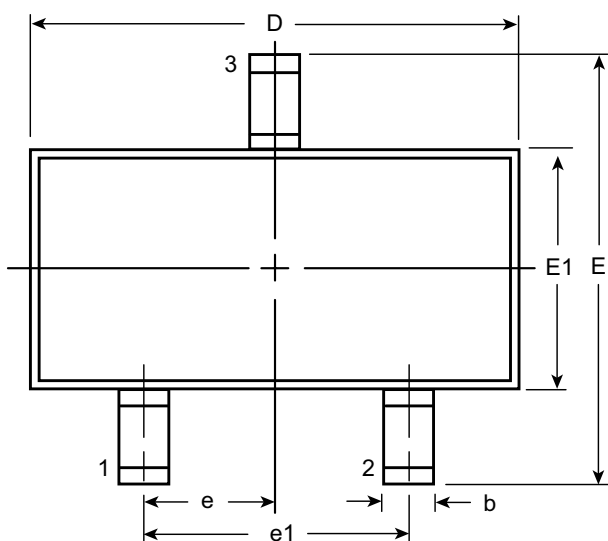

**Top View**

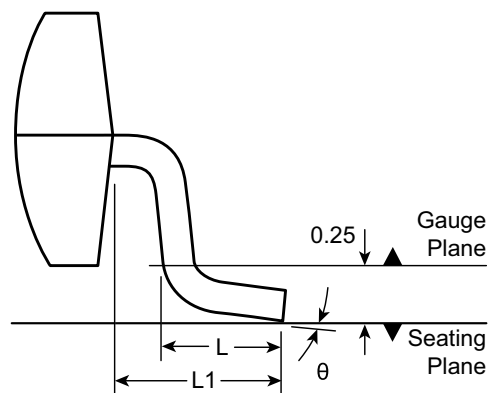

**View B**

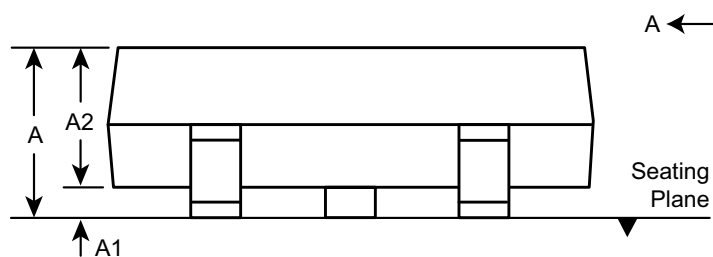

**Side View**

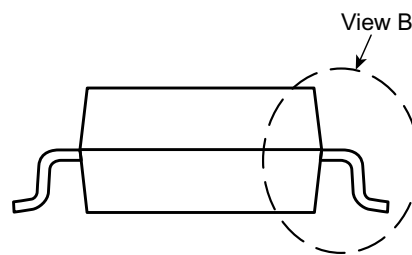

**View A - A**

Symbol		A	A1	A2	b	D	E	E1	e	e1	L	L1	$\theta$
Dimension (mm)	MIN	0.89	0.01	0.88	0.30	2.80	2.10	1.20	0.95 BSC	1.90 BSC	0.20 <sup>†</sup>	0.54 REF	0°
	NOM	-	-	0.95	-	2.90	-	1.30			0.50		-
	MAX	1.12	0.10	1.02	0.50	3.04	2.64	1.40			0.60		8°

JEDEC Registration TO-236, Variation AB, Issue H, Jan. 1999.

<sup>†</sup> This dimension differs from the JEDEC drawing.

Drawings not to scale.

Supertex Doc.#: DSPD-3TO236ABK1, Version C041309.

### 3-Lead TO-92 Package Outline (N3)

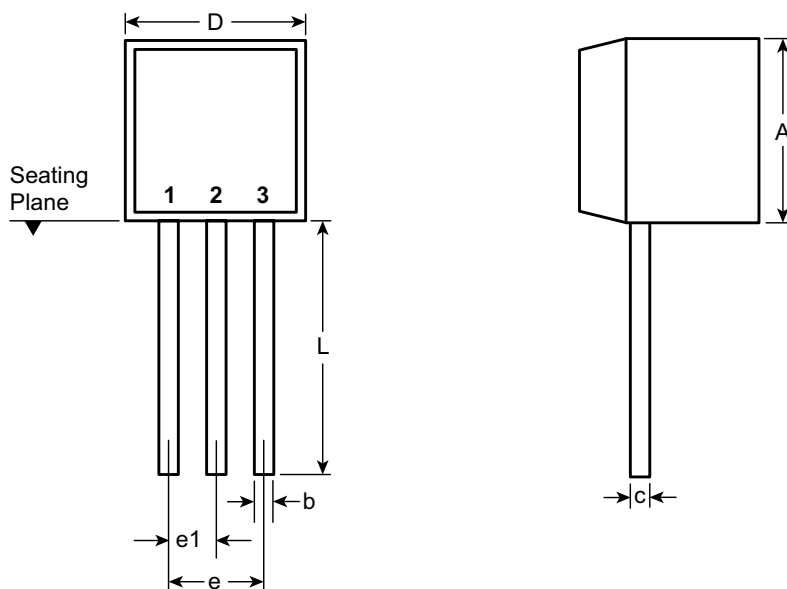

**Front View**

**Side View**

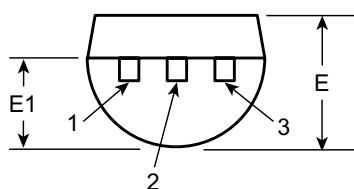

**Bottom View**

Symbol		A	b	c	D	E	E1	e	e1	L
Dimensions (inches)	MIN	.170	.014 <sup>†</sup>	.014 <sup>†</sup>	.175	.125	.080	.095	.045	.500
	NOM	-	-	-	-	-	-	-	-	-
	MAX	.210	.022 <sup>†</sup>	.022 <sup>†</sup>	.205	.165	.105	.105	.055	.610*

JEDEC Registration TO-92.

\* This dimension is not specified in the JEDEC drawing.

† This dimension differs from the JEDEC drawing.

**Drawings not to scale.**

**Supertex Doc.#:** DSPD-3TO92N3, Version E041009.

## 3-Lead TO-243AA (SOT-89) Package Outline (N8)

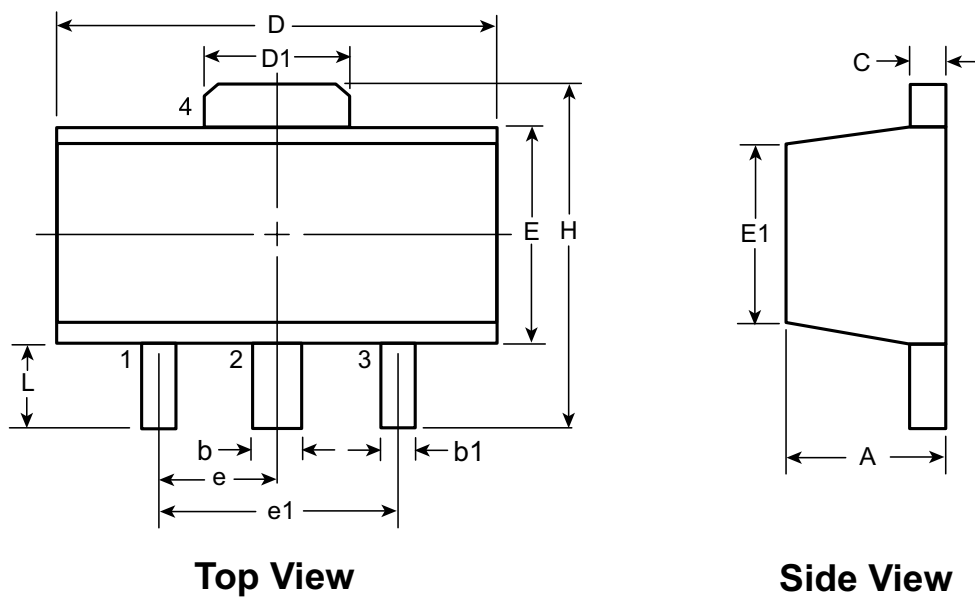

Symbol		A	b	b1	C	D	D1	E	E1	e	e1	H	L
Dimensions (mm)	MIN	1.40	0.44	0.36	0.35	4.40	1.62	2.29	2.00 <sup>†</sup>	1.50 BSC	3.00 BSC	3.94	0.73 <sup>†</sup>
	NOM	-	-	-	-	-	-	-	-			-	-
	MAX	1.60	0.56	0.48	0.44	4.60	1.83	2.60	2.29			4.25	1.20

JEDEC Registration TO-243, Variation AA, Issue C, July 1986.

<sup>†</sup> This dimension differs from the JEDEC drawing

Drawings not to scale.

Supertex Doc. #: DSPD-3TO243AAN8, Version F111010.

(The package drawing(s) in this data sheet may not reflect the most current specifications. For the latest package outline information go to <http://www.supertex.com/packaging.html>.)

**Supertex inc.** does not recommend the use of its products in life support applications, and will not knowingly sell them for use in such applications unless it receives an adequate "product liability indemnification insurance agreement." **Supertex inc.** does not assume responsibility for use of devices described, and limits its liability to the replacement of the devices determined defective due to workmanship. No responsibility is assumed for possible omissions and inaccuracies. Circuitry and specifications are subject to change without notice. For the latest product specifications refer to the **Supertex inc.** (website: <http://www.supertex.com>)