

TO-126 Plastic-Encapsulate Transistors

KSB1151 TRANSISTOR (PNP)

FEATURES

- Low Collector-Emitter Saturation Voltage
- Large Collector Current
- High Power Dissipation
- Complement to KSD1691

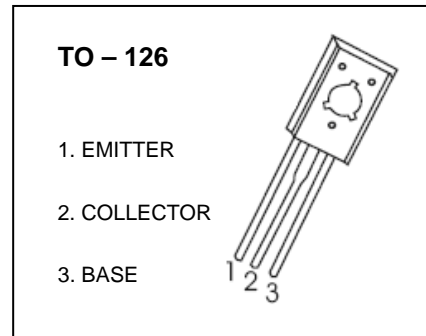

MARKING

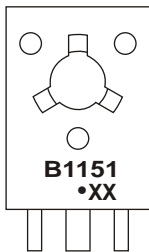

B1151=Device code
Solid dot= Green molding compound device, if none, the normal device
XX=Code

Equivalent Circuit

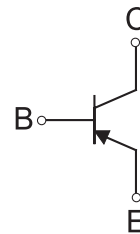

ORDERING INFORMATION

Part Number	Package	Packing Method	Pack Quantity
KSB1151	TO-126	Bulk	200pcs/Bag
KSB1151-TU	TO-126	Tube	60pcs/Tube

MAXIMUM RATINGS (T_a=25°C unless otherwise noted)

Symbol	Parameter	Value	Unit
V _{CBO}	Collector-Base Voltage	-60	V
V _{CEO}	Collector-Emitter Voltage	-60	V
V _{EBO}	Emitter-Base Voltage	-7	V
I _C	Collector Current	-5	A
P _C	Collector Power Dissipation	1.25	W
R _{θJA}	Thermal Resistance From Junction To Ambient	100	°C/W
T _J , T _{stg}	Operation Junction and Storage Temperature Range	-55~+150	°C

ELECTRICAL CHARACTERISTICS

$T_a=25\text{ }^\circ\text{C}$ unless otherwise specified

Parameter	Symbol	Test conditions	Min	Typ	Max	Unit
Collector-base breakdown voltage	$V_{(BR)CBO}$	$I_C=-100\mu\text{A}, I_E=0$	-60			V
Collector-emitter breakdown voltage	$V_{(BR)CEO}$	$I_C=-1\text{mA}, I_B=0$	-60			V
Emitter-base breakdown voltage	$V_{(BR)EBO}$	$I_E=-100\mu\text{A}, I_C=0$	-7			V
Collector cut-off current	I_{CBO}	$V_{CB}=-50\text{V}, I_E=0$			-10	μA
Emitter cut-off current	I_{EBO}	$V_{EB}=-7\text{V}, I_C=0$			-10	μA
DC current gain	$h_{FE(1)}$	$V_{CE}=-1\text{V}, I_C=-2\text{A}$	100		400	
	$h_{FE(2)}$	$V_{CE}=-1\text{V}, I_C=-0.1\text{A}$	60			
	$h_{FE(3)}$	$V_{CE}=-2\text{V}, I_C=-5\text{A}$	50			
Collector-emitter saturation voltage	$V_{CE(sat)}$	$I_C=-2\text{A}, I_B=-0.2\text{A}$			-0.3	V
Base-emitter saturation voltage	$V_{BE(sat)}$	$I_C=-2\text{A}, I_B=-0.2\text{A}$			-1.2	V

CLASSIFICATION OF $h_{FE(1)}$

RANK	O	Y	G
RANGE	100-200	160-320	200-400

Typical Characteristics

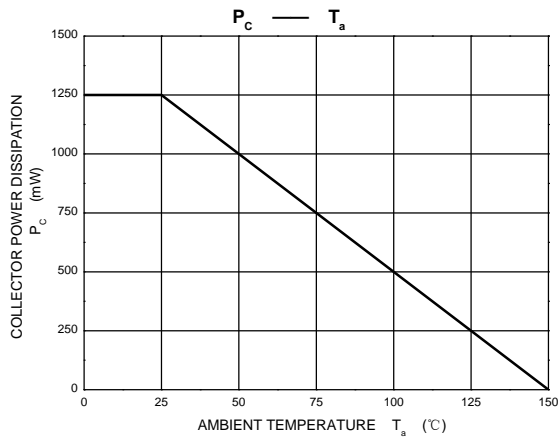
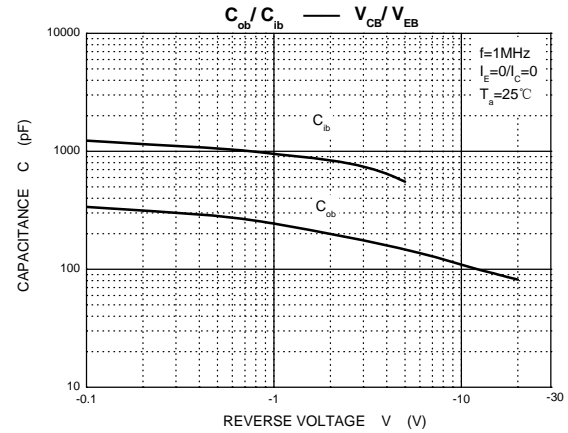
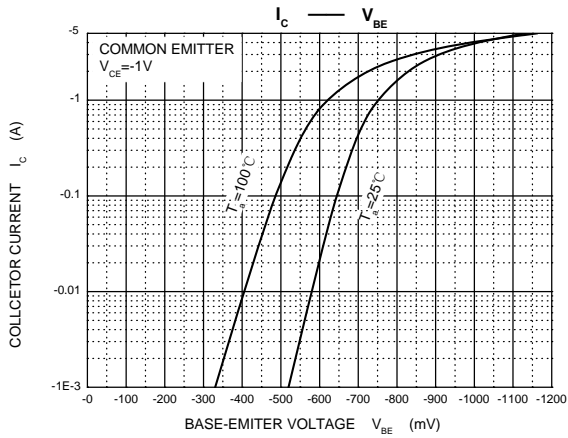
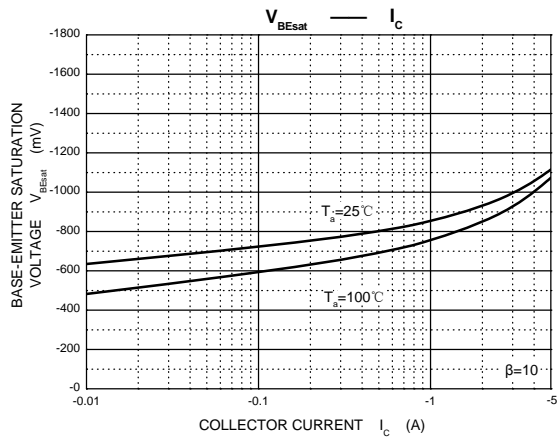
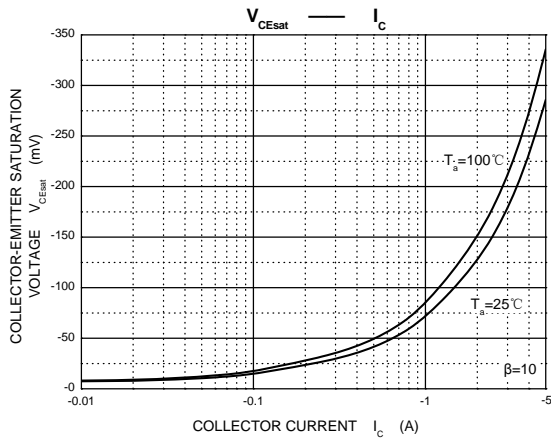
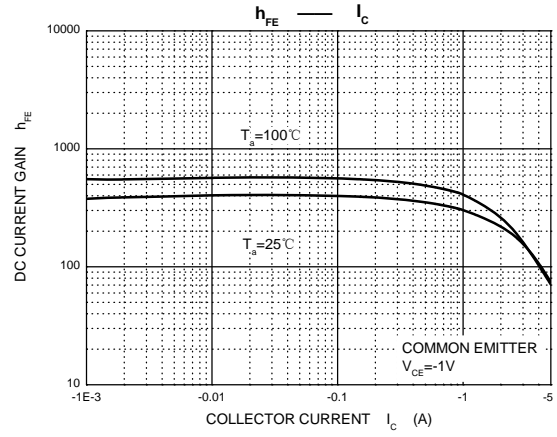
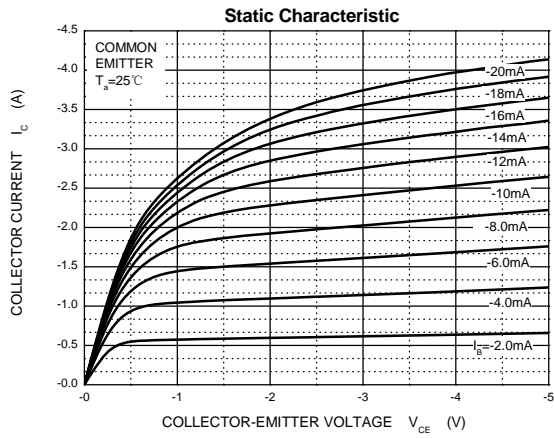

TO-126 Package Outline Dimensions



Symbol	Dimensions In Millimeters		Dimensions In Inches	
	Min	Max	Min	Max
A	2.500	2.900	0.098	0.114
A1	1.100	1.500	0.043	0.059
b	0.660	0.860	0.026	0.034
b1	1.170	1.370	0.046	0.054
c	0.450	0.600	0.018	0.024
D	7.400	7.800	0.291	0.307
E	10.600	11.000	0.417	0.433
e	2.290 TYP		0.090 TYP	
e1	4.480	4.680	0.176	0.184
h	0.000	0.300	0.000	0.012
L	15.300	15.700	0.602	0.618
L1	2.100	2.300	0.083	0.091
P	3.900	4.100	0.154	0.161
Φ	3.000	3.200	0.118	0.126